

Lantech

IPEC-0101FT

Industrial Switch

User Manual



V1.00
Sep-2007

FCC Warning

This Equipment has been tested and found to comply with the limits for a Class-A digital device, pursuant to Part 15 of the FCC rules. These limits are designed to provide reasonable protection against harmful interference in a residential installation. This equipment generates, uses, and can radiate radio frequency energy. It may cause harmful interference to radio communications if this equipment is not installed and used in accordance with the instructions. However, there is no guarantee that interference will not occur in a particular installation. If this equipment does cause harmful interference to radio or television reception, which can be determined by turning the equipment off and on, the user is encouraged to try to correct the interference by one or more of the following measures:

- Reorient or relocate the receiving antenna.
- Increase the separation between the equipment and receiver.
- Connect the equipment into an outlet on a circuit different from that to which the receiver is connected.
- Consult the dealer or an experienced radio/TV technician for help.

CE Mark Warning

This is a Class-A product. In a domestic environment this product may cause radio interference in which case the user may be required to take adequate measures.

Content

Introduction	1
Features.....	1
Package Contents.....	2
Hardware Description	3
Physical Dimension.....	3
Front Panel	3
Top View	4
LED Indicators	5
DIP-Switch	6
Ports.....	7
Cabling.....	9
Wiring the Power Inputs.....	10
Wiring the Fault Alarm Contact	11
Mounting Installation	12
DIN-Rail Mounting.....	12
Wall Mount Plate Mounting	14
Hardware Installation	15
Installation Steps.....	15
Network Application	16
Troubles shooting	17
Technical Specification	18

Introduction

The 1 10/100TX + 100FX w/ 1 PoE Injector Industrial Switch is a cost-effective solution and meets the high reliability requirements demanded by industrial applications. Using fiber port can extend the connection distance that increases the network elasticity and performance. Besides, the industrial switch provides the PoE function for kinds of Powered Devices to receive power as well as data over the RJ-45 cable.

Features

- System Interface/Performance
 - RJ-45 ports support Auto MDI/MDI-X Function
 - Embedded 1-port PoE Injection
 - Store-and-Forward Switching Architecture
 - Built-in Link Lose Forwarding Technology
- Power Supply
 - DC 48V Redundant Power
 - Overload Current Re-settable Fuse Present
- Case/Installation
 - IP-30 Protection
 - DIN Rail and Wall Mount Design
- Provides EFT protection 3,000 VDC for power line
- Supports 6,000 VDC Ethernet ESD protection

Package Contents

Please refer to the package contents list below to verify them against the checklist.

- 1 10/100TX + 100FX w/ 1 PoE Injector Industrial Switch
- User manual
- Pluggable Terminal Block
- 2 wall mount plates with screws
- One DIN-Rail (attached on the switch)

Compare the contents of the industrial switch with the standard checklist above. If any item is damaged or missing, please contact the local dealer for service.

Hardware Description

In this paragraph, the Industrial switch's hardware spec, port, cabling information, and wiring installation will be described.

Physical Dimension

1 10/100TX + 100FX w/ 1 PoE Injector Industrial Switch dimension (W x D x H) is **30mm x 95mm x 140mm**

Front Panel

The Front Panel of the 1 10/100TX + 100FX w/ 1 PoE Injector Industrial Switch is shown as below:



Front Panel of the PoE Injectors Industrial Switch

Top View

The top view of the 1 10/100TX + 100FX w/ 1 PoE Injector Industrial Switch has one terminal block connector of two DC power inputs.



Top View of the PoE Injectors Industrial Switch

LED Indicators

The diagnostic LEDs located on the front panel of the industrial switch provide real-time information of system and optional status. The following table provides the description of the LED status and their meanings for the switch.

LED	Color	Description	
P1	Green	On	Power input 1 is active
		Off	Power input 1 is inactive
P2	Green	On	Power input 2 is active
		Off	Power input 2 is inactive
Fault	Red	On	Power input 1/2 or port connections failed
		Off	Power input 1/2 and port connections are functional, or no power inputs
FDX/COL (fiber port)	Yellow	On	Full-duplex mode
		Flashing	Collision occurs
LNK/ACT (fiber port)	Green	On	Connected to network
		Flashing	Networking is active
		Off	Not connected to network
100M (RJ-45)	Yellow	On	Linking to 100Mbps network
		Off	Linking to 10Mbps network or disconnected
LNK/ACT (RJ-45)	Green	On	Connected to network
		Flashing	Networking is active
		Off	Not connected to network
FWD	Green	On	The port is supplying power to the powered-device
		Off	No powered-device attached or power supplying fails

DIP-Switch

The DIP-Switch is used to configure operation mode for **LLF** (Link Lose Forwarding)/**LFP** (Link Fault Pass-Through), and operation mode for UTP/Fiber port. The default value of DIP-switch is **OFF**.

S/W No	Status	Description
1	ON	Enables Port/Power Alarm
	OFF	Disable Port/Power Alarm
2	ON	Enables LLF/LFP
	OFF	Disables LLF/LFP
3	ON	100Base-FX Half-mode
	OFF	100Base-FX Full-mode
4	ON	Media mode (100TX to 100FX)
	OFF	Switching mode

LLF/LFP (DIP-Switch 2): Enabling LLF/LFP allows UTP/STP link failures to be reported to the fiber side and also allows Fiber link failures to be reported to the UTP/STP side. Therefore, a LLF/LFP feature is provided in both UTP/STP and Fiber side.

Media mode (DIP-Switch 4): When media mode is enabled (ON), it operates with the minimum latency. The transmission flow does not wait until entire frame is ready, but instead it forwards the received data immediately after the data being received. And TP port should be forced at 100M in this application. When DIP-Switch is set in switching mode (OFF), the function is the same as a Switch/Hub.

Note *Please don't change the DIP-switch setting when UTP/STP or fiber port is transmitting or receiving data. It may cause some data error. Besides, if you change the DIP-switch setting, please power off the switch and power on again to make the setting effective.*

Ports

■ RJ-45 ports

The UTP (RJ-45) Fast Ethernet ports will auto-sense for 10Base-T or 100Base-TX connections. Auto MDI/MDIX means that the switch can connect to another switch or workstation without changing straight through or crossover cabling. See the below figures for straight through and crossover cable schematic.

■ RJ-45 Pin Assignments

Pin Number	Assignment
1	Tx+
2	Tx-
3	Rx+
6	Rx-

Note “+” and “-” signs represent the polarity of the wires that make up each wire pair.

All ports on this industrial switch support automatic MDI/MDI-X operation, user can use straight-through cables (See figure below) for all network connections to PCs or servers, or to other switches or hubs. In straight-through cable, pins 1, 2, 3, and 6, at one end of the cable, are connected straight through to pins 1, 2, 3 and 6 at the other end of the cable. The table below shows the 10BASE-T/100BASE-TX MDI and MDI-X port pin outs.

Pin MDI-X	Signal Name	MDI Signal Name
1	Receive Data plus (RD+)	Transmit Data plus (TD+)
2	Receive Data minus (RD-)	Transmit Data minus (TD-)
3	Transmit Data plus (TD+)	Receive Data plus (RD+)
6	Transmit Data minus (TD-)	Receive Data minus (RD-)

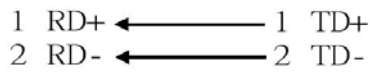
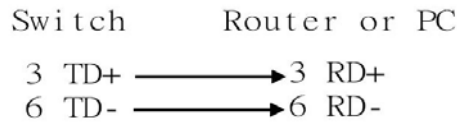

Straight Through Cable Schematic

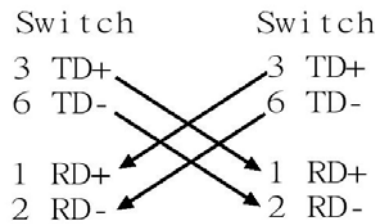

Cross Over Cable Schematic

■ Fiber Port

The fiber port of SC type connector can work in multi mode (2Km) or single mode (30Km).

When you connect the fiber port to another one, please follow the figure below to connect accordingly. Wrong connection will cause the port cannot work normally.

[Multi-Mode] power budget : Min: 9dB , MAX: 19dB.

[Single-Mode] power budget : Min: 19dB , MAX: 26dB.

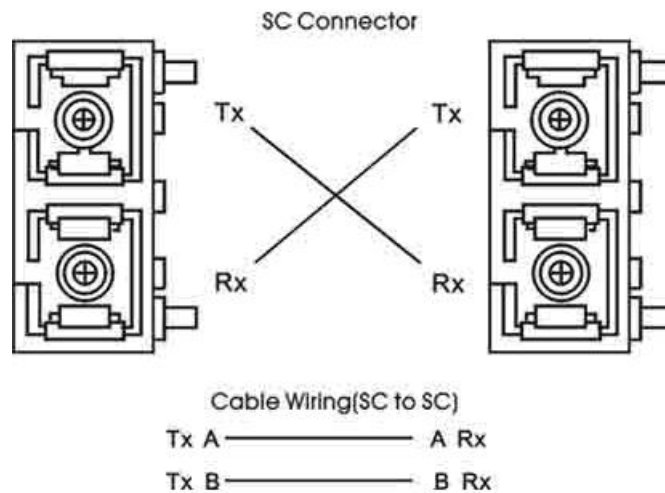

ATTENTION



This is a Class 1 Laser/LED product. Don't stare into the Laser/LED Beam.

Cabling

- Twisted-pair segment can be connected with unshielded twisted pair (UTP) or shielded twisted pair (STP) cable. The cable must comply with the IEEE 802.3u 100Base TX standard for Category 5. The cable between the converter and the link partner (switch, hub, workstation, etc.) must be less than 100 meters (328 ft.) long.
- Fiber segment using **single-mode** connector type must use 9/125 μ m single-mode fiber cable. User can connect two devices in the distance up to **30 Kilometers**.
- Fiber segment using **multi-mode** connector type must use 50 or 62.5/125 μ m multi-mode fiber cable. User can connect two devices up to **2Km** distances.

Wiring the Power Inputs

Please follow the steps below to insert the power wire.

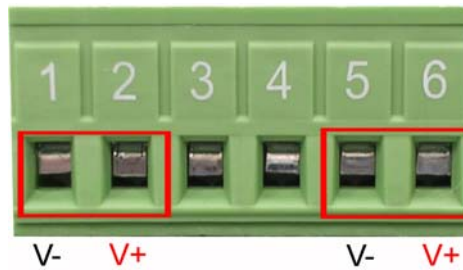

Insert the positive and negative wires into the V+ and V- contacts on the terminal block connector.



Tighten the wire-clamp screws for preventing the wires from loosing.

Wiring the Fault Alarm Contact

The fault alarm contact is in the middle of terminal block connector as the picture shows below. Inserting the wires, it will detect the fault status including power failure or port link failure (managed industrial switch only) and form an open circuit. An application example for the fault alarm contact is shown as below:



Insert the wires into the fault alarm contact.

Note *The wire gauge for the terminal block should be in the range between 12~ 24 AWG.*

Mounting Installation

DIN-Rail Mounting

The DIN-Rail is screwed on the industrial switch when out of factory. If the DIN-Rail is not screwed on the industrial switch, please see the following pictures to screw the DIN-Rail on the switch. Follow the steps below to hang the industrial switch.

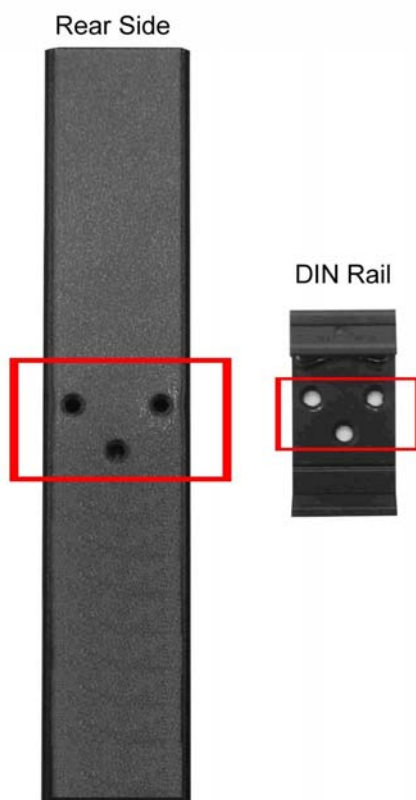

1. Use the screws to screw the DIN-Rail on the rear side of the industrial switch.
2. To remove the DIN-Rail, reverse the step 1.

3. After the DIN-Rail is screwed on the rear side of the switch, insert the top of DIN-Rail into the track.

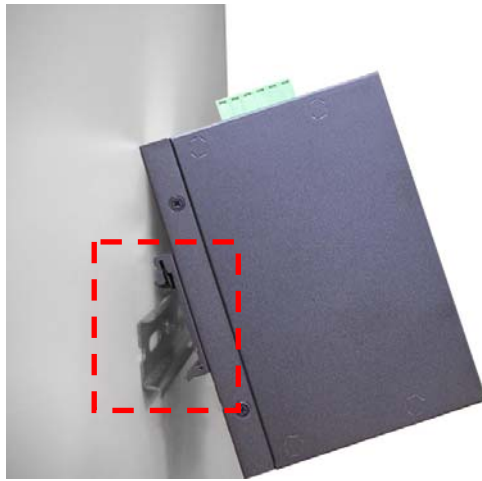

4. Then, lightly push the DIN-Rail into the track.

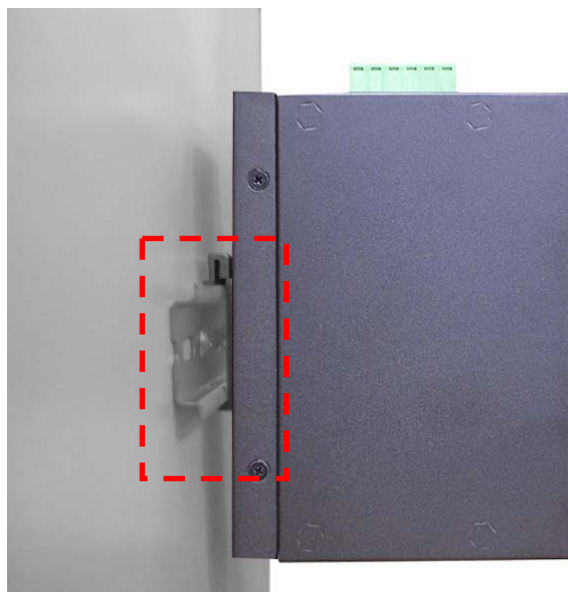

5. Check if the DIN-Rail is tightened on the track or not.
6. To remove the industrial switch from the track, reverse steps above.

Wall Mount Plate Mounting

Follow the steps below to mount the industrial switch with wall mount plate.

1. Remove the DIN-Rail from the industrial switch; loose the screws to remove the DIN-Rail.
2. Place the wall mount plate on the top & bottom side of the industrial switch.
3. Use the screws to screw the wall mount plate on the industrial switch.
4. Use the hook holes at the corners of the wall mount plate to hang the industrial switch on the wall.
5. To remove the wall mount plate, reverse steps above.

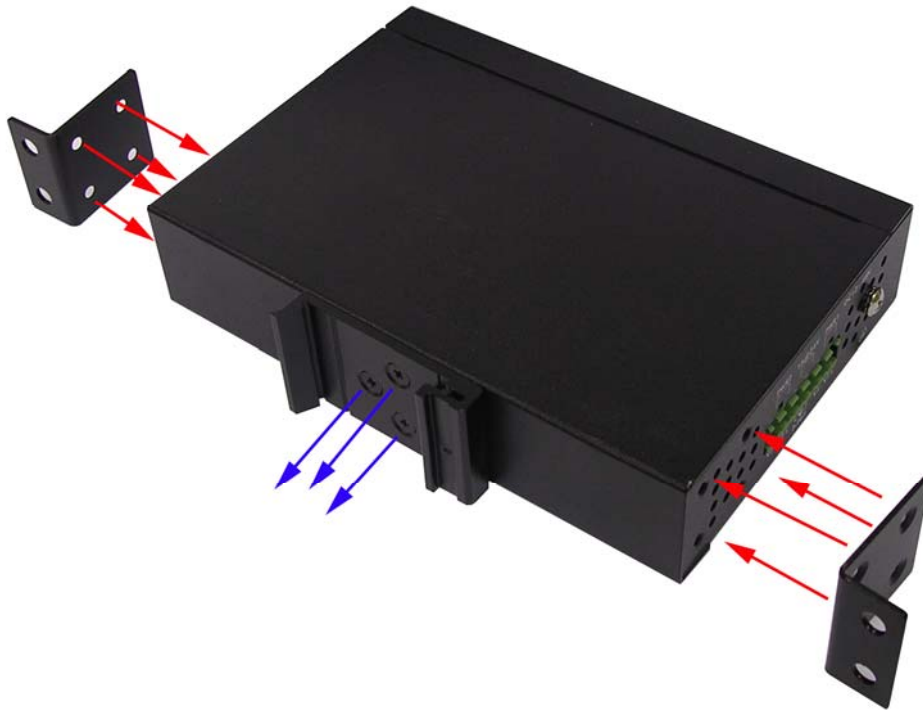

Hardware Installation

In this paragraph, we are going to mention how to install the 1 10/100TX + 100FX w/ 1 PoE Injector Industrial Switch and the installation points to be attended to it.

Installation Steps

1. Unpack the Industrial switch packing.
2. Check if the DIN-Rail is screwed on the Industrial switch or not. If the DIN-Rail is not screwed on the Industrial switch, please refer to **DIN-Rail Mounting** section for DIN-Rail installation. If user want to wall mount the Industrial switch, then please refer to **Wall Mount Plate Mounting** section for wall mount plate installation.
3. To hang the Industrial switch on the DIN-Rail track or wall, please refer to the **Mounting Installation** section.
4. Power on the Industrial switch. Please refer to the **Wiring the Power Inputs** section for knowing the information about how to wire the power. The power LED on the Industrial switch will light up. Please refer to the **LED Indicators** section for indication of LED lights.
5. Prepare the twisted-pair, straight through Category 5e/above cable for Ethernet connection.
6. Insert one side of the RJ-45 cable into the Industrial switch Ethernet port and another side to the network device's Ethernet port, e.g. Switch, PC or Server. The UTP/STP port (RJ-45) LED on the Industrial switch will light up when the cable is connected with the network device. Please refer to the **LED Indicators** section for LED light indication.
7. When all connections are set and LED lights all show in normal, the installation is complete.

Network Application

This segment provides the sample to help the user have more actual idea of industrial switch application. For a sample application of the industrial switch, see the figure below.

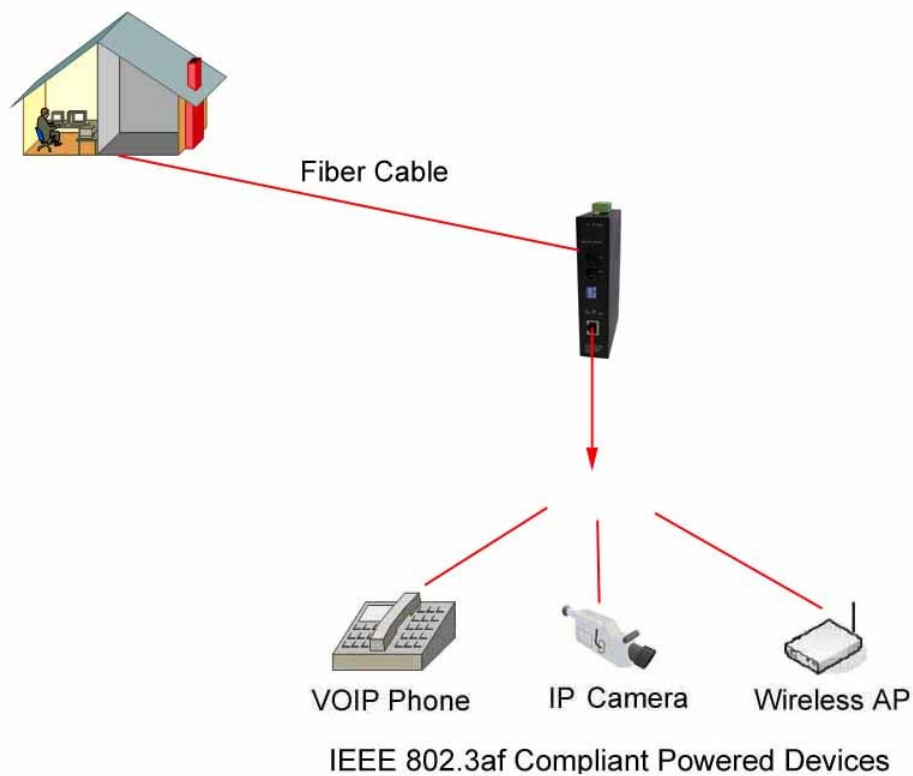

Troubles shooting

- Verify that is using the right power cord/adapter (DC 48V), please don't use the power adapter with DC output voltage higher than 48V, or it will burn this converter down.
- Select the proper UTP/STP cable to construct your network. Please check that is using the right cable. Use unshielded twisted-pair (UTP) or shield twisted-pair (STP) cable for RJ-45 connections: 100 Ω Category 3, 4 or 5 cable for 10Mbps connections, 100 Ω Category 5 cable for 100Mbps connections, or 100 Ω Category 5e/above cable for 1000Mbps. Also be sure that the length of any twisted-pair connection does not exceed 100 meters (328 feet).
- **Diagnosing LED Indicators:** the Switch can be easily monitored through panel indicators, which describes common problems user may encounter and where user can find possible solutions, to assist in identifying problems.
- If the power indicator does not light on when the power cord is plugged in, user may have a problem with power cord. Then check for loose power connections, power losses or surges at power outlet. If you still cannot resolve the problem, contact the local dealer for assistance.
- If the Industrial switch LED indicators are normal and the connected cables are correct but the packets still cannot transmit. Please check your system's Ethernet devices' configuration or status.

Technical Specification

The 1 10/100TX + 100FX w/ 1 PoE Injector Industrial Switch technical specifications is shown as below.

Standard	IEEE 802.3 10Base-T Ethernet IEEE 802.3u 100Base-TX/FX IEEE802.3x Flow Control and Back Pressure IEEE802.3af Power over Ethernet
Protocol	CSMA/CD
Transfer Rate	14,880 pps for 10Base-T Ethernet port 148,800 pps for 100Base-TX/FX Fast Ethernet port
Packet Buffer	1Mbits
LED	RJ-45: Link/Activity (Green), 100M (Yellow), Power Feeding (Green) Fiber: FDX/COL (Yellow), Link/Activity (Green) Per unit: Power 1 (Green), Power 2 (Green), Fault (Red)
Network Cable	10Base-T: 2-pair UTP/STP Cat. 3, 4, 5, 5e cable EIA/TIA-568 100-ohm (100m) 100Base-TX: 2-pair UTP/STP Cat. 5/5E cable EIA/TIA-568 100-ohm (100m)
Optical cable	Distance: Multi mode: 50/125 μ m ~ 62.5/125 μ m Single mode: 9/125 μ m Available distance: 2km (multi-mode)/30km (single-mode) Wavelength: 1310nm (Multi-mode/Single-mode) [Multi-Mode] power budget : Min: 9dB , MAX: 19dB. [Single-Mode] power budget : Min: 19dB , MAX: 26dB.

Power Supply	Redundant power DC 48V with connective removable terminal block
Power Consumption	3.3Watts (without PoE); 16.4Watts (Full load with PoE)
Installation	DIN rail kit for DIN-type cabinet install and wall-mount ear for wall mounting
Operating Temp.	-10°C to 60°C
Operation Humidity	5% to 95% (Non-condensing)
Storage Temperature	-40°C to 85°C
Case Dimension	IP-30, 30 mm (W) x 95 mm (D) x 140mm (H)
EMI	FCC Class A CE EN61000-4-2/3/4/5/6/8/11/12 CE EN61000-6-2 CE EN61000-6-4
Safety	UL cUL CE/EN60950-1
Stability testing	IEC60068-2-32 (Free fall) IEC60068-2-27 (Shock) IEC60068-2-6 (Vibration)