

Lantech

7 10/100TX + 3 100/1000M dual speed SFP Combo SNMP Industrial Switch

User Manual

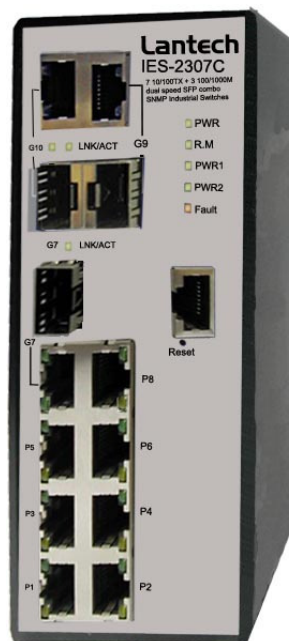

Notice

The contents of this manual are based on the table below listing firmware version, software kernel version, and hardware version. If the switch functions are different from the description of the manual, please contact the local sale dealer for more information.

Firmware Version	V1.04
Kernel Version	V1.57
Hardware Version	-----

FCC Warning

This Equipment has been tested and found to comply with the limits for a Class-A digital device, pursuant to Part 15 of the FCC rules. These limits are designed to provide reasonable protection against harmful interference in a residential installation. This equipment generates, uses, and can radiate radio frequency energy. It may cause harmful interference to radio communications if the equipment is not installed and used in accordance with the instructions. However, there is no guarantee that interference will not occur in a particular installation. If this equipment does cause harmful interference to radio or television reception, which can be determined by turning the equipment off and on, the user is encouraged to try to correct the interference by one or more of the following measures:

- Reorient or relocate the receiving antenna.
- Increase the separation between the equipment and receiver.
- Connect the equipment into an outlet on a circuit different from that to which the receiver is connected.
- Consult the dealer or an experienced radio/TV technician for help.

CE Mark Warning

This is a Class-A product. In a domestic environment this product may cause radio interference in which case the user may be required to take adequate measures.

Content

Introduction	1
Features	1
Software Specification	3
Package Contents.....	5
Hardware Description	6
Physical Dimension.....	6
Front Panel	6
Top View	7
LED Indicators	8
Ports.....	9
Cabling.....	12
Wiring the Power Inputs.....	15
Wiring the Fault Alarm Contact	16
Mounting Installation	17
DIN-Rail Mounting.....	17
Wall Mount Plate Mounting	19
Hardware Installation	20
Installation Steps.....	20
Network Application	21
X-Ring Application	22
Coupling Ring Application.....	23
Dual Homing Application.....	24
Console Management	25
Connecting to the Console Port	25

Pin Assignment	25
Login in the Console Interface	26
CLI Management	27
Commands Level.....	27
Commands Set List.....	29
System Commands Set	29
Port Commands Set.....	31
Trunk Commands Set.....	34
VLAN Commands Set.....	35
Spanning Tree Commands Set.....	37
QOS Commands Set	40
IGMP Commands Set.....	40
Mac / Filter Table Commands Set.....	41
SNMP Commands Set.....	42
Port Mirroring Commands Set.....	44
802.1x Commands Set	45
TFTP Commands Set	47
SystemLog, SMTP and Event Commands Set.....	48
SNTP Commands Set.....	49
X-ring Commands Set.....	51
Web-Based Management	52
About Web-based Management	52
Preparing for Web Management.....	52
System Login	53
System Information	54
IP Configuration	54
DHCP Server – System configuration.....	55

DHCP Server – Client Entries	57
DHCP Server - Port and IP Bindings	57
TFTP - Update Firmware	58
TFTP – Restore Configuration	58
TFTP - Backup Configuration	59
System Event Log – Syslog Configuration.....	59
System Event Log - SMTP Configuration	60
System Event Log - Event Configuration	62
Fault Relay Alarm	63
SNTP Configuration	64
IP Security.....	67
User Authentication.....	68
Digital Input/Output	69
Port Statistics	70
Port Control.....	71
Port Trunk	72
Aggregator setting	72
Aggregator Information	74
State Activity.....	75
Port Mirroring	76
Rate Limiting	77
VLAN configuration	79
VLAN configuration - Port-based VLAN	79
802.1Q VLAN.....	83
Rapid Spanning Tree	86
RSTP - System Configuration.....	86

RSTP - Port Configuration	88
SNMP Configuration	89
System Configuration.....	90
Trap Configuration	91
SNMPV3 Configuration.....	92
QoS Configuration	95
QoS Policy and Priority Type	95
Port-based Priority	96
COS Configuration.....	97
TOS Configuration	97
IGMP Configuration	98
X-Ring	99
Security	102
802.1X/Radius Configuration	102
MAC Address Table.....	105
Factory Default.....	108
Save Configuration	108
System Reboot	108
Troubles shooting	110
Technical Specification.....	111

Introduction

The 7 10/100TX + 3 100/1000M dual speed SFP Combo SNMP Industrial Switch is a cost-effective solution and meets the high reliability requirements demanded by industrial applications. Using fiber port can extend the connection distance that increases the network elasticity and performance.

Features

- System Interface/Performance
 - RJ-45 ports support Auto MDI/MDI-X Function
 - SFP (mini-GBIC) supports 100/1000 Dual Mode
 - Store-and-Forward Switching Architecture
 - Back-plane (Switching Fabric): 7.4Gbps
 - 1Mbits Packet Buffer
 - 8K MAC Address Table
- Case/Installation
 - IP-30 Protection
 - DIN-Rail and Wall Mount Design
- Power Supply
 - Wide-range Redundant Power Design
 - Power Polarity Reverse Protect
 - Overload Current Protection
- Spanning Tree
 - Supports IEEE 802.1d Spanning Tree
 - Supports IEEE 802.1w Rapid Spanning Tree
- VLAN
 - Port Based VLAN
 - Supports 802.1 Q Tag VLAN
 - GVRP
- X-Ring
 - X-Ring, Dual Homing, and Couple Ring Topology

- Provides redundant backup feature and the recovery time below 20ms
- Port Trunk with LACP
- Supports IEEE802.1ab LLDP**
- QoS (Quality of Service)
 - Supports IEEE 802.1p Class of Service
 - Per port provides 4 priority queues
 - Port Base, Tag Base and Type of Service Priority
- Bandwidth Control
 - Supports Rate-based and Priority-based Ingress Rate Limiting
 - Broadcast/Multicast Packet Filter Control
- Port Mirror: Monitor traffic in switched networks
 - TX Packet only
 - RX Packet only
 - Both of TX and RX Packet
- System Event Log
 - System Log Server/Client
 - SMTP e-mail Alert
 - Relay Alarm Output System Events
- Security
 - Port Security : MAC address entries/filter
 - IP Security: IP address security management to prevent unauthorized intruder
 - Login Security: IEEE802.1X/RADIUS
- SNMP Trap
 - Device cold start
 - Power status
 - Authentication failure
 - X-Ring topology change
 - Port Link up/Link down
- IGMP with Query mode for Multi Media Application
- TFTP Firmware Update, System Configuration Restore and Backup
- Provides EFT protection 3,000 V_{DC} for power line
- Supports 6,000 V_{DC} Ethernet ESD protection
- Supports DIDO function

Software Specification

Management	<p>SNMP v1, v2c and v3 management</p> <p>Web interface management</p> <p>Telnet interface management</p> <p>Command Line Interface (CLI) management</p>
SNMP MIB	<p>RFC 1215 Trap</p> <p>RFC 1213 MIBII</p> <p>RFC 1157 SNMP MIB</p> <p>RFC 1493 Bridge MIB</p> <p>RFC 2674 VLAN MIB</p> <p>RFC 1643</p> <p>RFC 1757</p> <p>RSTP MIB</p> <p>Private MIB</p>
VLAN	<p>Port based VLAN</p> <p>IEEE802.1Q Tag VLAN (256 entries)/VLAN ID (up to 4k in number which can be assigned from 1 to 4096)</p> <p>GVRP (256 groups)</p>
Port Trunk with LACP	<p>LACP Port Trunk: 4 Trunk groups/Maximum 4 trunk members</p>
LLDP**	<p>Supports LLDP that allows the switch to advertise its identity and capabilities on the LAN</p>
Spanning tree	<p>IEEE802.1d spanning tree</p> <p>IEEE802.1w rapid spanning tree.</p>
X-Ring	<p>Supports X-Ring, Dual Homing, and Couple Ring</p> <p>Provides redundant backup feature and the recovery time below 20ms</p>
Quality of service	<p>The quality of service determined by port, Tag and IPv4 Type of Service, IPv4/IPv6 Different Service</p>
Class of service	<p>Supports IEEE 802.1p class of service, per port provides 4 priority queues</p>

Port Security	Supports 100 entries of MAC address for static MAC and another 100 for MAC filter
Port mirror	TX packet only RX packet only, Both of TX and RX packets
IGMP	Supports IGMP snooping v1, v2 and v3 Up to 256 multicast groups and IGMP query
IP Security	Supports 10 IP addresses that have permission to access the switch management and to prevent unauthorized intruder
Login Security	Supports IEEE802.1X Authentication/RADIUS
Bandwidth control	Supports ingress packet filter and egress packet limit The egress rate control supports all of packet type and the limit rates are 100K ~ 250Mbps Ingress filter packet type combination rules are Broadcast/Multicast/Unknown Unicast packet, Broadcast/Multicast packet, Broadcast packet only and all of packets The packet filter rate can be set from 100k to 250Mbps
Flow Control	Supports Flow Control for Full-duplex and Back Pressure for Half-duplex
System Log	Supports System log record and remote system log server
SMTP	Supports SMTP Server and 6 e-mail accounts for receiving event alert
Relay Alarm	Provides one relay output for port breakdown & power fail Alarm Relay current carry ability: 1A @ DC24V
SNMP Trap	Up to 3 Trap stations Cold start, Port link up, Port link down, Authentication Failure, Private Trap for power status, Power Alarm configuration, Fault Alarm, X-Ring topology change

DHCP	Provides DHCP Client/DHCP Server and IP Relay
DNS	Provides DNS client feature Supports Primary and Secondary DNS Server
SNTP	Supports SNTP to synchronize system clock in Internet
Firmware update, configuration upload/download	TFTP firmware update, system configuration backup and restore Supports binary configuration file for system quick installation

* Future release

** Optional

Package Contents

Please refer to the package content list below to verify them against the checklist.

- 7 10/100TX + 3 100/1000M dual speed SFP Combo SNMP Industrial Switch x 1
- Pluggable Terminal Block x 1
- User manual x 1
- Mounting plate x 2
- RJ-45 to DB9-Female cable x 1

Compare the contents of the industrial switch with the standard checklist above. If any item is damaged or missing, please contact the local dealer for service.

Hardware Description

In this paragraph, we will describe the Industrial switch's hardware spec, port, cabling information, and wiring installation.

Physical Dimension

7 10/100TX + 3 100/1000M dual speed SFP Combo SNMP Industrial Switch dimension (W x D x H) is **72mm x 105mm x 152mm**

Front Panel

The front panel of the 7 10/100TX + 3 100/1000M dual speed SFP Combo SNMP Industrial Switch is shown as below:

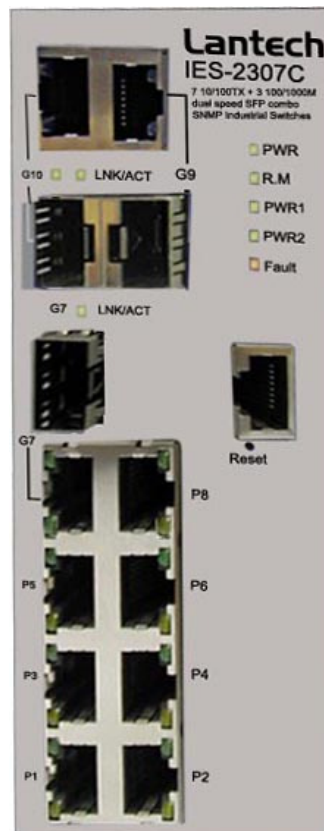

Front Panel of the industrial switch

Top View

The top panel of the 7 10/100TX + 3 100/1000M dual speed SFP Combo SNMP Industrial Switch has one terminal block connector of two DC power inputs.

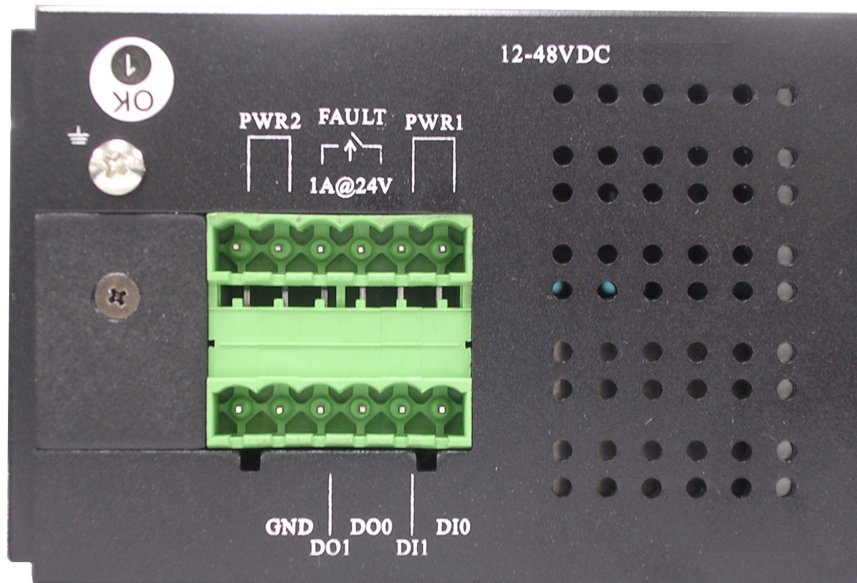

Top Panel of the industrial switch

LED Indicators

The diagnostic LEDs located on the front panel of the industrial switch provide real-time information of system and optional status. The following table provides description of the LED status and their meanings for the switch.

LED	Status	Meaning
PWR	Green	System power on
	Off	No power inputs
R.M.	Green	The industrial switch is the master device of the X-Ring group
	Off	The industrial switch is not the master device of the X-Ring group
PWR1	Green	Power 1 is active
	Off	Power 1 is inactive
PWR2	Green	Power 2 is active
	Off	Power 2 is inactive
Fault	Red	PWR1/PWR2 is inactive
	Off	PWR1 & PWR2 are both active or no power inputs
P1 ~ P6 & P8	Green (Upper LED)	Connected to network
	Blinking (Upper LED)	Networking is active
	Off (Upper LED)	Not connected to network

	Yellow (Lower LED)	Ethernet port full duplex
	Blinking (Lower LED)	Collision of packets occurs
	Off (Lower LED)	Ethernet port half duplex or not connected to network
P7, P9, P10 (10/100/1000T)	Green (Upper LED)	Connected to network
	Blinking (Upper LED)	Networking is active
	Off (Upper LED)	Not connected to network
	Green (Lower LED)	The port is operating at speed of 1000M
	Off (Lower LED)	The port is disconnected or operates at speed of 10/100M
P7, P9, P10 Link/Active (100/1000 SFP)	Green	SFP port is connected to network
	Blinking	Networking is active
	Off	Not connected to network

Ports

■ RJ-45 ports

The UTP/STP ports will auto-sense for 10Base-T/100Base-TX connections (Fast Ethernet) or 10Base-T, 100Base-TX, or 1000Base-T connections (Gigabit Ethernet). Auto MDI/MDIX means that the switch can connect to another switch or workstation without changing straight through or crossover cabling. See the figures below for straight through and crossover cable schematic.

■ **RJ-45 Pin Assignments**

Pin Number	Assignment
1	Tx+
2	Tx-
3	Rx+
6	Rx-

Note “+” and “-” signs represent the polarity of the wires that make up each wire pair.

All ports on this industrial switch support automatic MDI/MDI-X operation, user can use straight-through cables (See figure below) for all network connections to PCs or servers, or to other switches or hubs. In straight-through cable, pins 1, 2, 3, and 6, at one end of the cable, are connected straight through to pins 1, 2, 3 and 6 at the other end of the cable. The following table shows the MDI and MDI-X port pin outs.

Pin MDI-X	Signal Name	MDI Signal Name
1	Receive Data plus (RD+)	Transmit Data plus (TD+)
2	Receive Data minus (RD-)	Transmit Data minus (TD-)
3	Transmit Data plus (TD+)	Receive Data plus (RD+)
6	Transmit Data minus (TD-)	Receive Data minus (RD-)

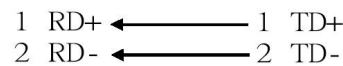
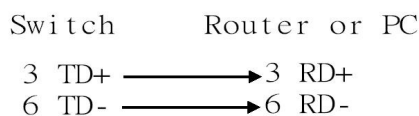

Straight Through Cable Schematic

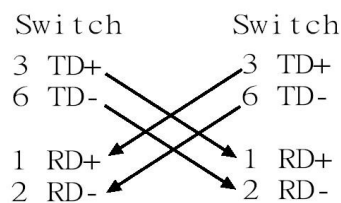

Cross Over Cable Schematic

■ 3 Gigabit Copper/SFP (Mini-GBIC) combo port:

The Industrial switch has three auto-detected Giga port—UTP/STP/Fiber combo ports. The Gigabit Copper (10/100/1000T) ports should use Category 5e or above UTP/STP cable for the connection up to 1000Mbps. The small form-factor pluggable (SFP) is a compact optical transceiver used in optical communications for both telecommunication and data communications. The SFP slots supporting dual mode can switch the connection speed between 100 and 1000Mbps. They are for connecting to the network segment with single or multi-mode fiber. You can choose the appropriate SFP module to plug into the slots. Then use proper multi-mode or single-mode fiber according to the used SFP module. With fiber optic, it transmits at speed up to 1000 Mbps and you can prevent noise interference from the system; the transmission distance depending on the mini-GBIC module is up to 110 km.

Note *The SFP/Copper Combo port can't be used at the same time. The SFP port has the higher priority than copper port; if you insert the 1000M SFP transceiver (which is connected to the remote device) into the SFP port, the connection of the accompanying copper port will link down.*

If you insert the 100M SFP transceiver into the SFP port even without a fiber connection to the remote, the connection of the accompanying copper port will link down immediately.

The user must use the class I optical transceivers which conform to U.S. code of federal regulation, 21 CFR 1040.

Cabling

Twisted-pair segment can be established by using unshielded twisted pair (UTP) or shielded twisted pair (STP) cabling. The cable between the link partner (switch, hub, workstation, etc.) and the converter must be less than 100 meters (328 ft.) long and comply with the IEEE 802.3ab 1000Base-T standard for Category 5e or above.

Fiber segment using single-mode connector type must use 9/125 μ m single-mode fiber cable. You can connect two devices in the distance of 10 km. Fiber segment using multi-mode connector type must use 50/125 or 62.5/125 μ m multi-mode fiber cable. You can connect two devices up to 550m distances.

The small form-factor pluggable (SFP) is a compact optical transceiver used in optical communications for both telecommunication and data communication applications.

To connect the transceiver and LC cable, please follow the steps shown below:

First, insert the transceiver into the SFP module. Notice that the triangle mark is the bottom of the module.

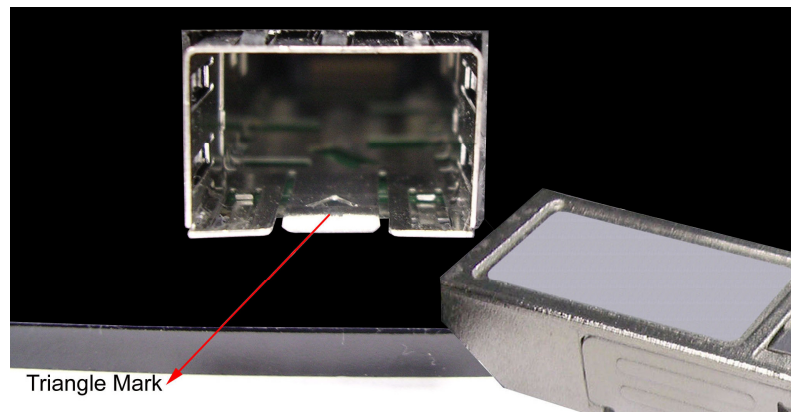

Transceiver to the SFP module

Make sure the module is aligned correctly and then slide the module into the SFP slot until a click is heard.

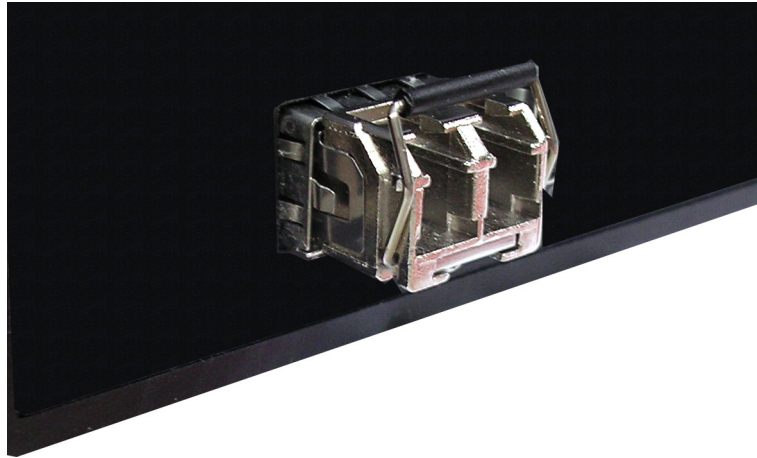

Transceiver Inserted

Second, insert the fiber cable of LC connector into the transceiver.

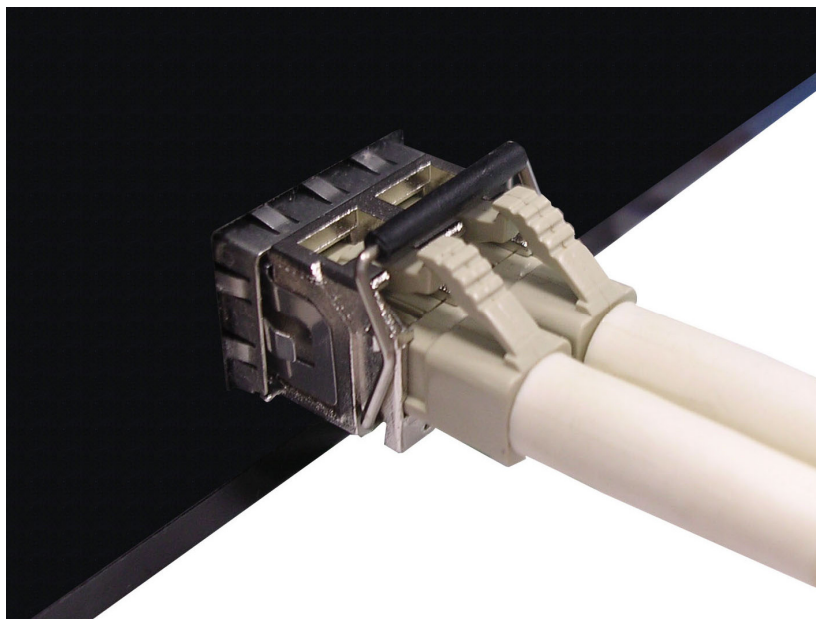

LC connector to the transceiver

To remove the LC connector from the transceiver, please follow the steps shown below:

First, press the upper side of the LC connector from the transceiver and pull it out to release.

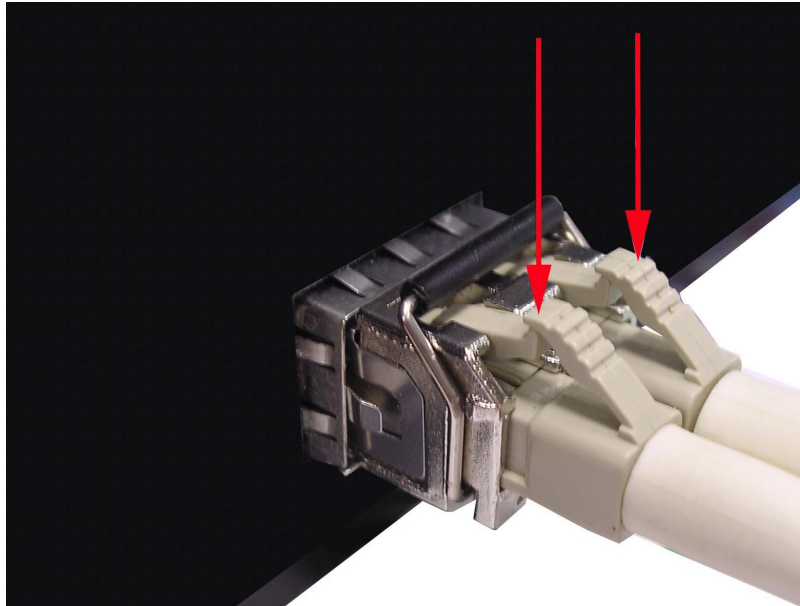

Remove LC connector

Second, push down the metal loop and pull the transceiver out by the plastic part.

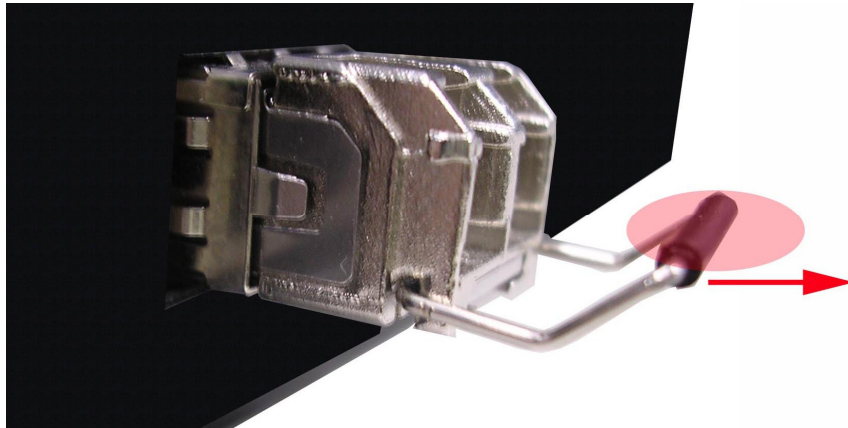

Pull out from the SFP module

Wiring the Power Inputs

Please follow the steps below to insert the power wire.

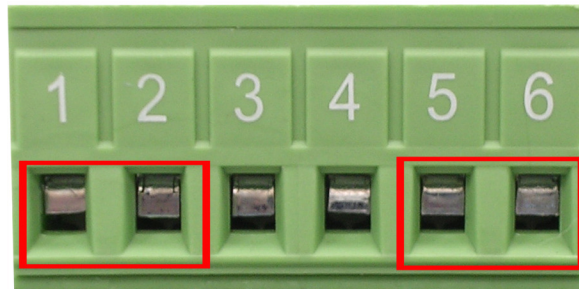

1. Insert AC or DC power wires into the contacts 1 and 2 for power 1, or 5 and 6 for power 2.

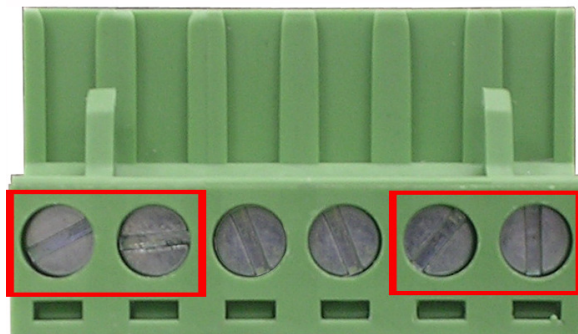

2. To tighten the wire-clamp screws for preventing the wires from losing.

Wiring the Fault Alarm Contact

The fault alarm contacts are in the middle of terminal block connector as the picture shows below. Inserting the wires, it will detect the fault status of power failure, or port link failure (for managed model) and form an open circuit.

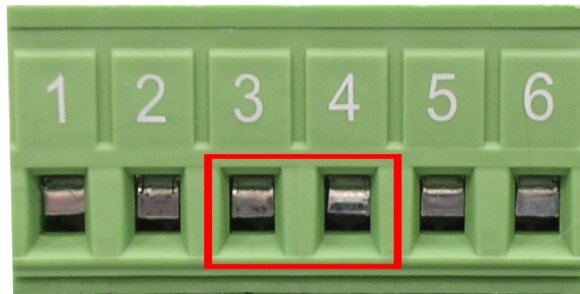

Insert the wires into the fault alarm contacts (No. 3 & 4)

Note *The wire gauge for the terminal block should be in the range between 12~ 24 AWG.*

Mounting Installation

DIN-Rail Mounting

The DIN-Rail is screwed on the industrial switch when out of factory. If the DIN-Rail is not screwed on the industrial switch, please see the following pictures to screw the DIN-Rail on the switch. Follow the steps below to hang the industrial switch.

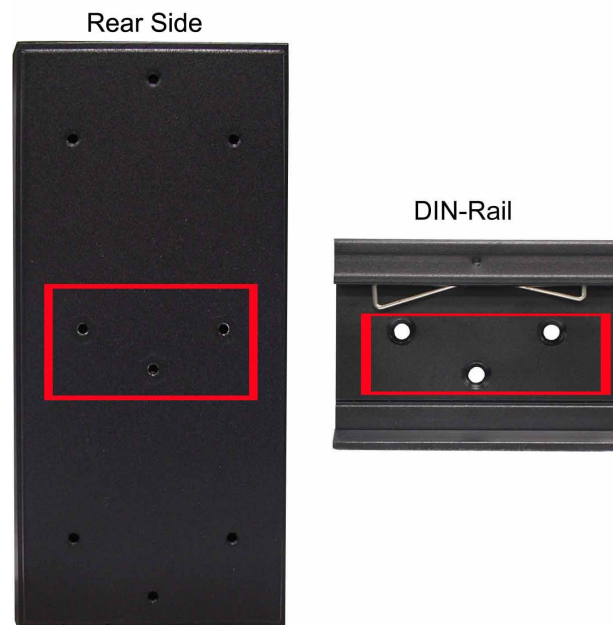

1. First, insert the top of DIN-Rail into the track.

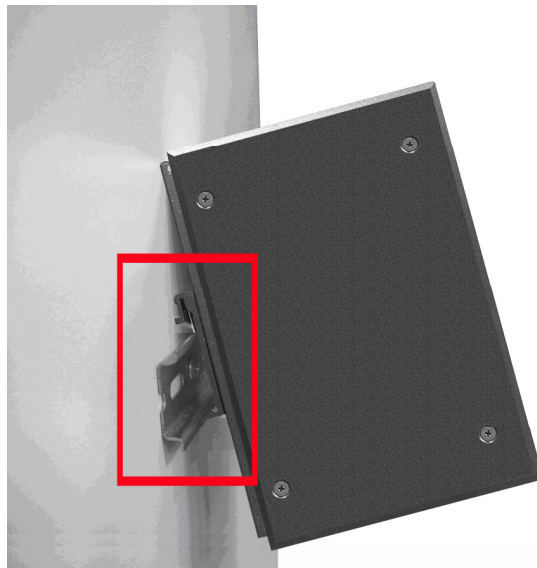

2. Then, lightly push the DIN-Rail into the track.

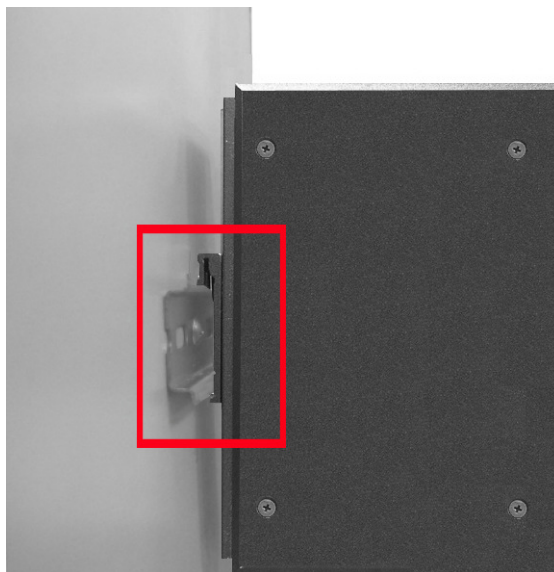

3. Check if the DIN-Rail is tightened on the track or not.
4. To remove the industrial switch from the track, reverse above steps.

Wall Mount Plate Mounting

Follow the steps below to mount the industrial switch with wall mount plate.

1. Remove the DIN-Rail from the industrial switch; loose the screws to remove the DIN-Rail.
2. Place the wall mount plate on the rear panel of the industrial switch.
3. Use the screws to screw the wall mount plate on the industrial switch.
4. Use the hook holes at the corners of the wall mount plate to hang the industrial switch on the wall.
5. To remove the wall mount plate, reverse the above steps.

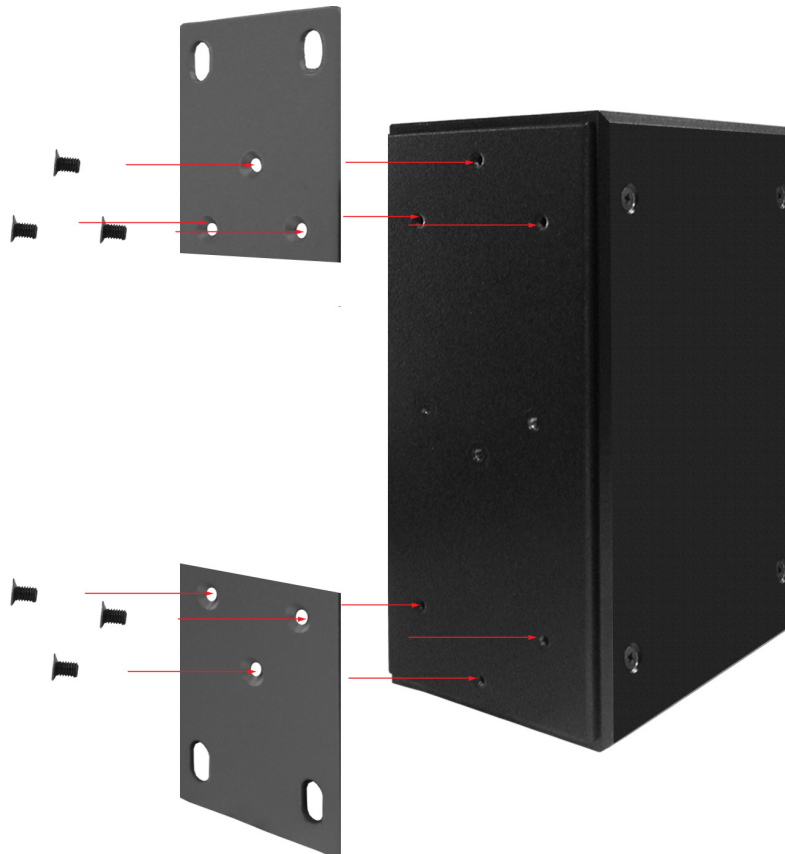

Hardware Installation

In this paragraph, we will describe how to install the 7 10/100TX + 3 10/100/1000T/100/1000 SFP Combo w/ X-Ring L2 Managed Industrial Switch and the installation points to be attended to it.

Installation Steps

1. Unpack the Industrial switch packing.
2. Check if the DIN-Rail is screwed on the Industrial switch or not. If the DIN-Rail is not screwed on the Industrial switch, please refer to **DIN-Rail Mounting** section for DIN-Rail installation. If the user wants to wall mount the Industrial switch, then please refer to **Wall Mount Plate Mounting** section for wall mount plate installation.
3. To hang the Industrial switch on the DIN-Rail track or wall, please refer to the **Mounting Installation** section.
4. Power on the Industrial switch. Please refer to the **Wiring the Power Inputs** section for knowing the information about how to wire the power. The power LED on the Industrial switch will light up. Please refer to the **LED Indicators** section for indication of LED lights.
5. Prepare the twisted-pair, straight through Category 5/above cable for Ethernet connection.
6. Insert one end of UTP/STP cable into the Industrial switch RJ-45 port and the other end to the network device's RJ-45 port, e.g. Switch PC or Server. The RJ-45 port LED on the Industrial switch will light up when the cable is connected with the network device. Please refer to the **LED Indicators** section for LED light indication.
7. When all connections are set and LED lights all show in normal, the installation is complete.

Network Application

This chapter provides some sample applications to help the user to have more actual idea of industrial switch function application. A sample application of the industrial switch is shown as below:

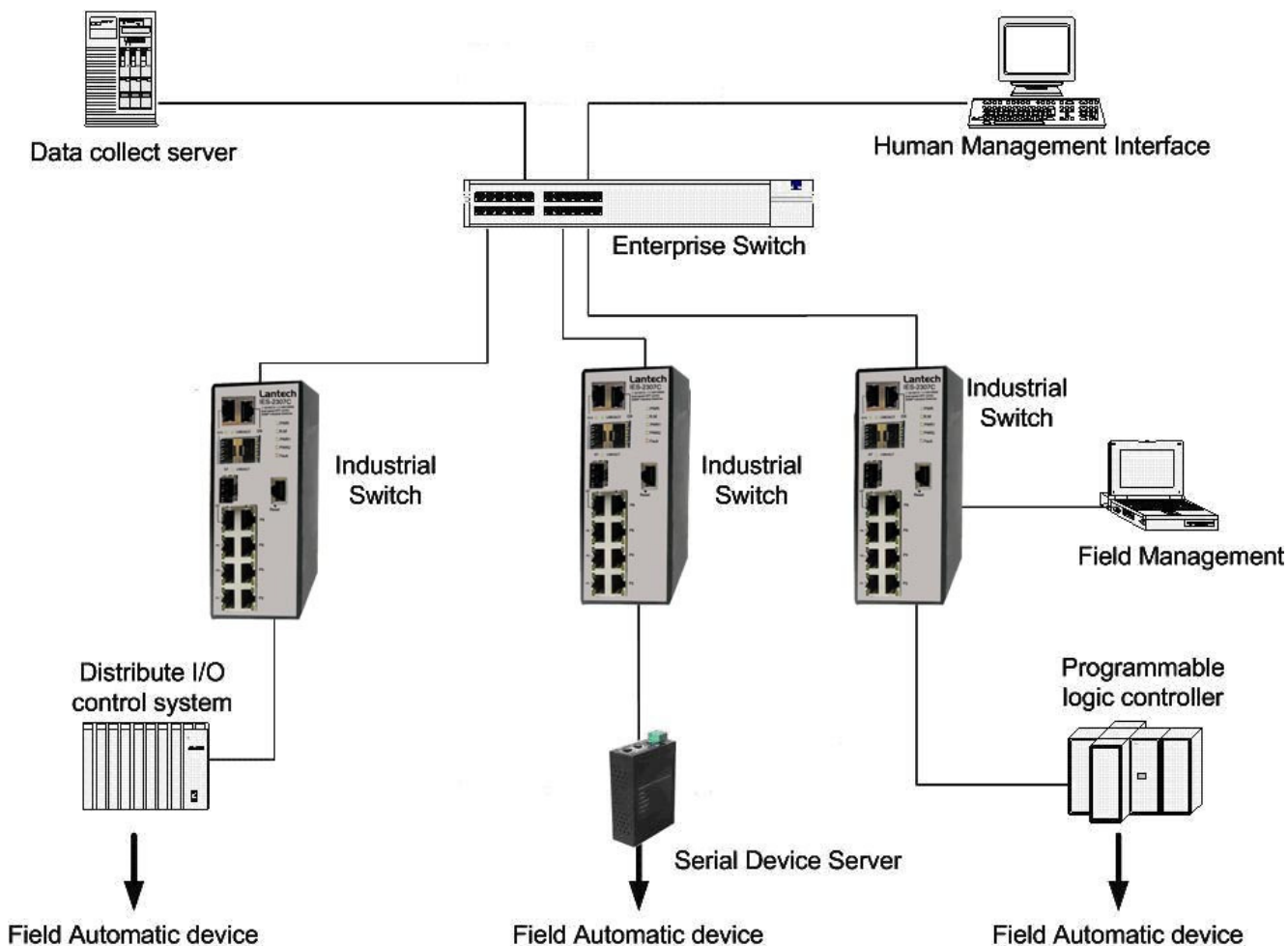

X-Ring Application

The industrial switch supports the X-Ring protocol that can help the network system to recover from network connection failure within 20ms or less, and make the network system more reliable. The X-Ring algorithm is similar to Spanning Tree Protocol (STP) and Rapid STP (RSTP) algorithm but its recovery time is less than STP/RSTP. The figure below is a sample of X-Ring application.

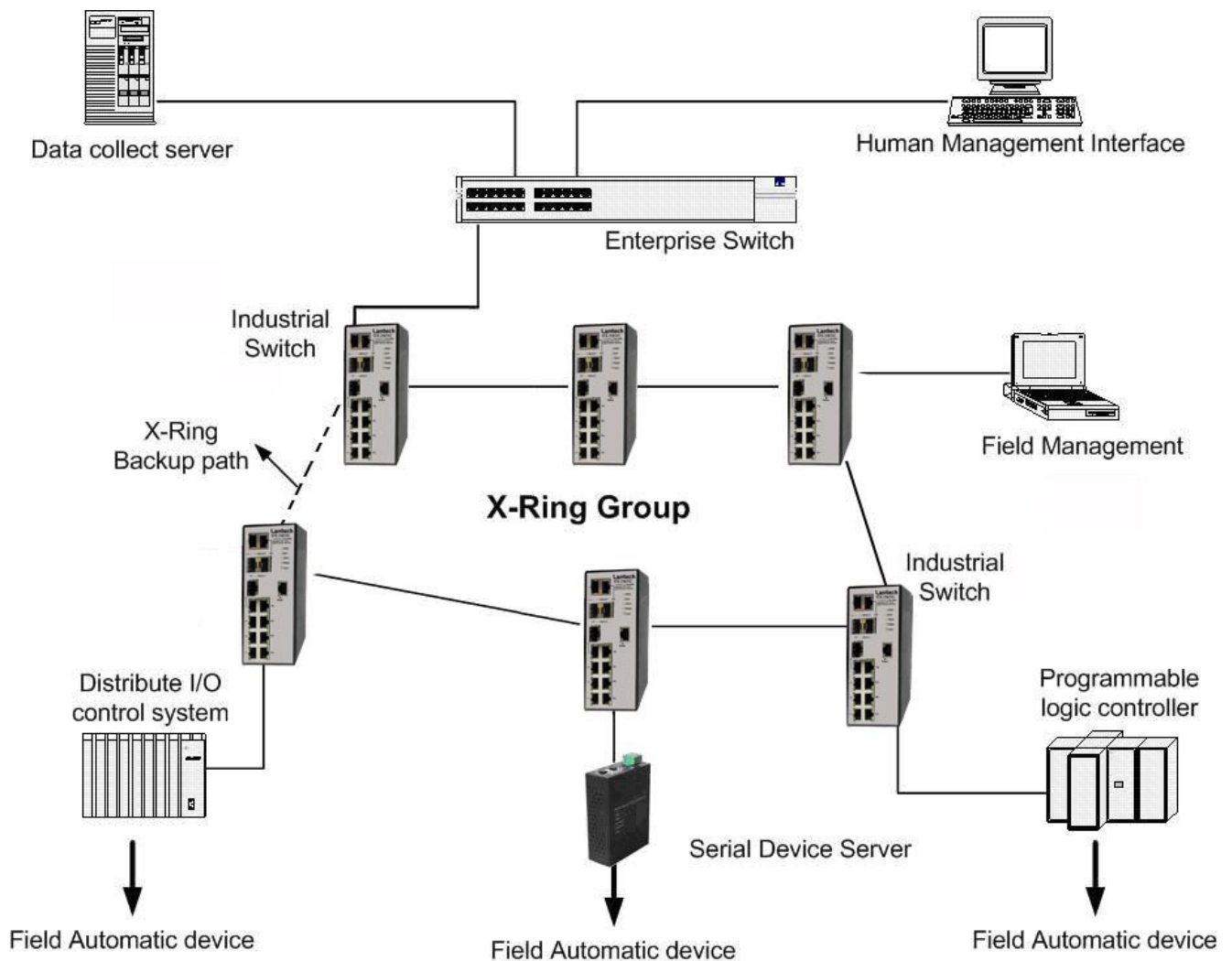

Coupling Ring Application

In the network, it may have more than one X-Ring group. Using the coupling ring function can connect each X-Ring for the redundant backup. It can ensure the transmissions between two ring groups not to fail. The following figure is a sample of coupling ring application.

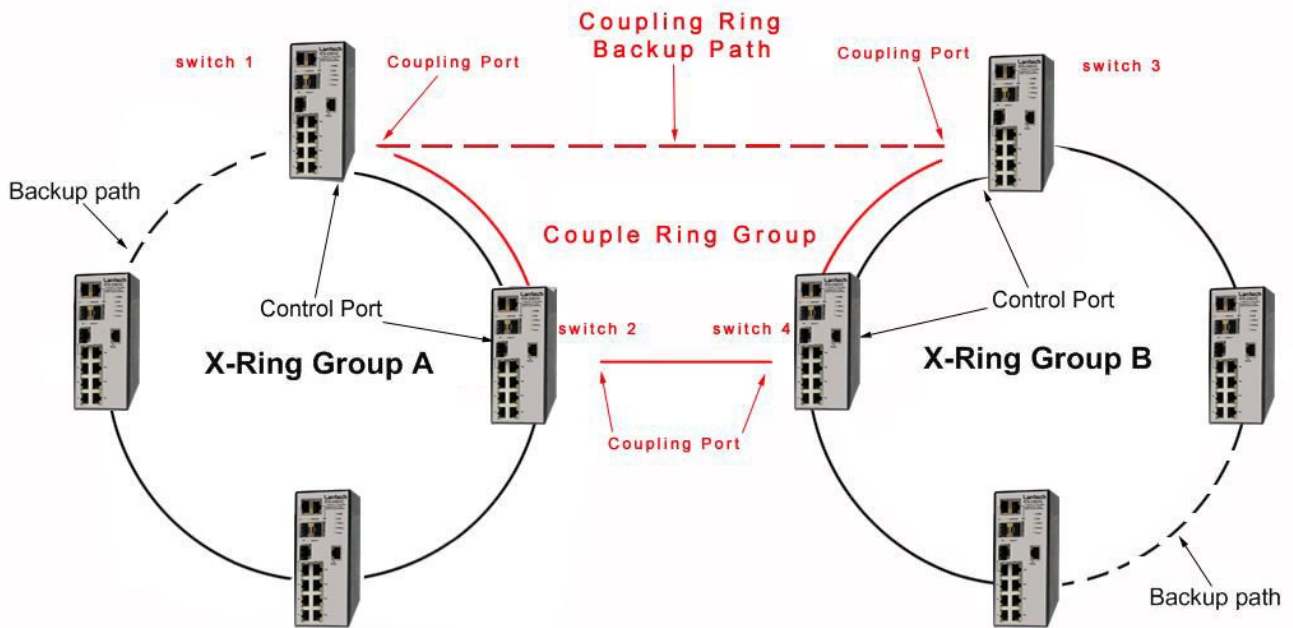

Dual Homing Application

Dual Homing function is to prevent the connection loss from between X-Ring group and upper level/core switch. Assign two ports to be the Dual Homing port that is backup port in the X-Ring group. The Dual Homing function only works when the X-Ring function is active. Each X-Ring group only has one Dual Homing port.

[NOTE] In Dual Homing application architecture, the upper level switches need to enable the Rapid Spanning Tree Protocol.

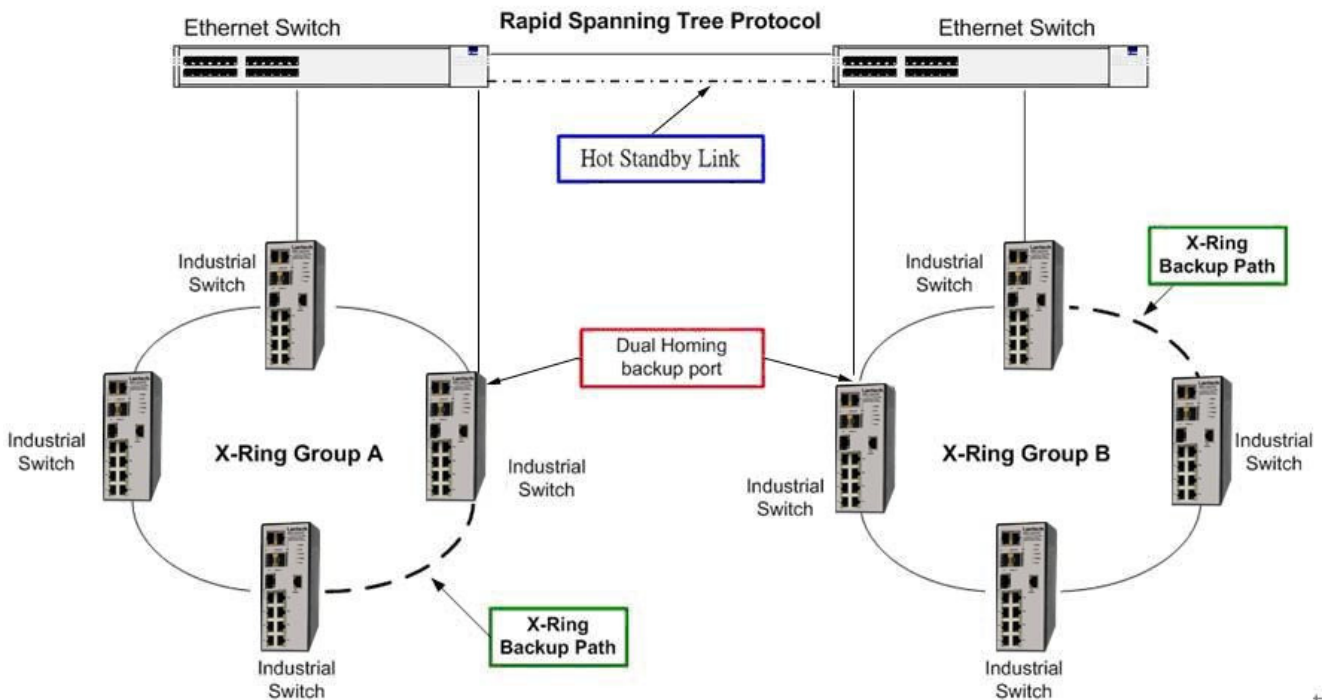

Console Management

Connecting to the Console Port

The supplied cable which one end is RS-232 connector and the other end is RJ-45 connector. Attach the end of RS-232 connector to PC or terminal and the other end of RJ-45 connector to the console port of the switch. The connected terminal or PC must support the terminal emulation program.

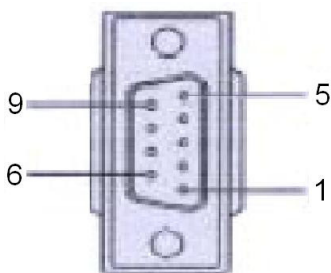
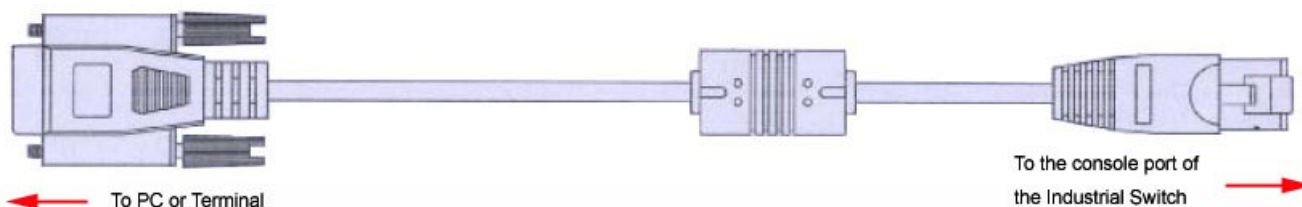

DB 9-pin Female

Pin Assignment

DB9 Connector	RJ-45 Connector
NC	1 Orange/White
2	2 Orange
3	3 Green/White
NC	4 Blue
5	5 Blue/White
NC	6 Green
NC	7 Brown/White
NC	8 Brown

Login in the Console Interface

When the connection between Switch and PC is ready, turn on the PC and run a terminal emulation program or **Hyper Terminal** and configure its **communication parameters** to match the following default characteristics of the console port:

Baud Rate: 9600 bps

Data Bits: 8

Parity: none

Stop Bit: 1

Flow control: None

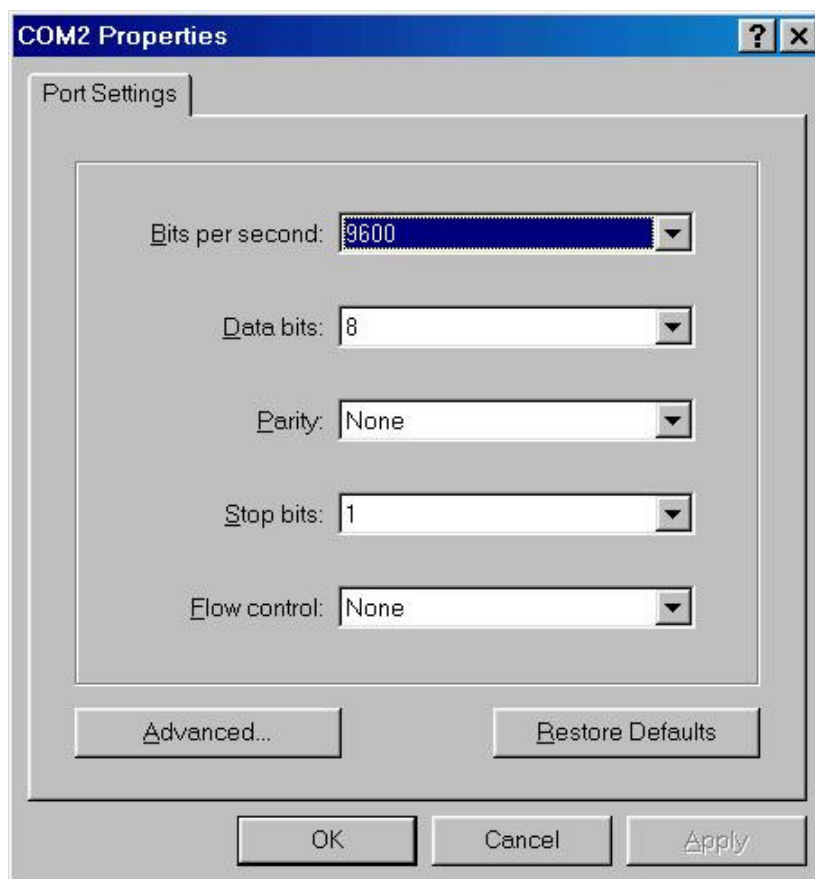

The settings of communication parameters

After finishing the parameter settings, click 'OK' button. When the blank screen shows up, press **Enter** key to bring out the login prompt. Key in '**root**' (default value) for both User name and Password (use **Enter** key to switch), then press **Enter** key and the Main Menu of console management appears.

```
User Name : root
Password : ****
```

Console login interface

CLI Management

The system supports the console management—CLI command. After you log in on to the system, you will see a command prompt. To enter CLI management interface, type in “enable” command.

```
switch>e
switch#
```

CLI command interface

The following table lists the CLI commands and description.

Commands Level

Modes	Access Method	Prompt	Exit Method	About This Mode
User EXEC	Begin a session with your switch.	switch>	Enter logout or quit .	The user commands available at the user level are a subset of those available at the privileged level. Use this mode to <ul style="list-style-type: none"> • Perform basic tests. • Display system information.

Privileged EXEC	Enter the enable command while in User EXEC mode.	switch#	Enter disable to exit.	The privileged command is the advanced mode. Use this mode to <ul style="list-style-type: none"> • Display advanced function status • Save configuration
Global Configuration	Enter the configure command while in privileged EXEC mode.	switch (config)#	To exit to privileged EXEC mode, enter exit or end	Use this mode to configure those parameters that are going to be applied to your switch.
VLAN database	Enter the vlan database command while in privileged EXEC mode.	switch (vlan)#	To exit to user EXEC mode, enter exit .	Use this mode to configure VLAN-specific parameters.
Interface configuration	Enter the interface of fast Ethernet command (with a specific interface) while in global configuration mode	switch (config-if)#	To exit to global configuration mode, enter exit . To exit to privileged EXEC mode, enter exit or end .	Use this mode to configure parameters for the switch and Ethernet ports.

Commands Set List

User EXEC	E
Privileged EXEC	P
Global configuration	G
VLAN database	V
Interface configuration	I

System Commands Set

Commands	Level	Description	Example
show config	E	Show switch configuration	switch> show config
show terminal	P	Show console information	switch# show terminal
write memory	P	Save user configuration into permanent memory (flash rom)	switch# write memory
system name [System Name]	G	Configure system name	switch(config)# system name xxx
system location [System Location]	G	Set switch system location string	switch(config)# system location xxx
system description [System Description]	G	Set switch system description string	switch(config)# system description xxx
system contact [System Contact]	G	Set switch system contact window string	switch(config)# system contact xxx
show system-info	E	Show system information	switch> show system-info
ip address [Ip-address] [Subnet-mask] [Gateway]	G	Configure the IP address of switch	switch(config)# ip address 192.168.1.1 255.255.255.0 192.168.1.254
ip dhcp	G	Enable DHCP client function of switch	switch(config)# ip dhcp

show ip	P	Show IP information of switch	switch# show ip
no ip dhcp	G	Disable DHCP client function of switch	switch(config)# no ip dhcp
reload	G	Halt and perform a cold restart	switch(config)# reload
default	G	Restore to default	switch(config)# default
admin username [Username]	G	Changes a login username. (maximum 10 words)	switch(config)# admin username xxxxxx
admin password [Password]	G	Specifies a password (maximum 10 words)	switch(config)# admin password xxxxxx
show admin	P	Show administrator information	switch# show admin
dhcpserver enable	G	Enable DHCP Server	switch(config)# dhcpserver enable
Dhcpserver disable	G	Disable DHCP Server	switch(config)# no dhcpserver
dhcpserver lowip [Low IP]	G	Configure low IP address for IP pool	switch(config)# dhcpserver lowip 192.168.1.100
dhcpserver highip [High IP]	G	Configure high IP address for IP pool	switch(config)# dhcpserver highip 192.168.1.200
dhcpserver subnetmask [Subnet mask]	G	Configure subnet mask for DHCP clients	switch(config)# dhcpserver subnetmask 255.255.255.0
dhcpserver gateway [Gateway]	G	Configure gateway for DHCP clients	switch(config)# dhcpserver gateway 192.168.1.254
dhcpserver dnsip [DNS IP]	G	Configure DNS IP for DHCP clients	switch(config)# dhcpserver dnsip 192.168.1.1
dhcpserver leasetime [Hours]	G	Configure lease time (in hour)	switch(config)# dhcpserver leasetime 1
dhcpserver ipbinding [IP address]	I	Set static IP for DHCP clients by port	switch(config)# interface fastEthernet 2 switch(config)# dhcpserver ipbinding 192.168.1.1
show dhcpserver configuration	P	Show configuration of DHCP server	switch# show dhcpserver configuration

show dhcpserver clients	P	Show client entries of DHCP server	switch# show dhcpserver clients
show dhcpserver ip-binding	P	Show IP-Binding information of DHCP server	switch# show dhcpserver ip-binding
no dhcpserver	G	Disable DHCP server function	switch(config)# no dhcpserver
security enable	G	Enable IP security function	switch(config)# security enable
security http	G	Enable IP security of HTTP server	switch(config)# security http
security telnet	G	Enable IP security of telnet server	switch(config)# security telnet
security ip [Index(1..10)] [IP Address]	G	Set the IP security list	switch(config)# security ip 1 192.168.1.55
show security	P	Show the information of IP security	switch# show security
no security	G	Disable IP security function	switch(config)# no security
no security http	G	Disable IP security of HTTP server	switch(config)# no security http
no security telnet	G	Disable IP security of telnet server	switch(config)# no security telnet

Port Commands Set

Commands	Level	Description	Example
interface fastEthernet [Portid]	G	Choose the port for modification.	switch(config)# interface fastEthernet 2
duplex [full half]	I	Use the duplex configuration command to specify	switch(config)# interface fastEthernet 2 switch(config-if)# duplex full

		the duplex mode of operation for Fast Ethernet.	
speed [10 100 1000 auto]	I	Use the speed configuration command to specify the speed mode of operation for Fast Ethernet., the speed can't be set to 1000 if the port isn't a giga port..	switch(config)# interface fastEthernet 2 switch(config-if)# speed 100
no flowcontrol	I	Disable flow control of interface	switch(config-if)# no flowcontrol
security enable	I	Enable security of interface	switch(config)# interface fastEthernet 2 switch(config-if)# security enable
no security	I	Disable security of interface	switch(config)# interface fastEthernet 2 switch(config-if)# no security
bandwidth type all	I	Set interface ingress limit frame type to "accept all frame"	switch(config)# interface fastEthernet 2 switch(config-if)# bandwidth type all
bandwidth type broadcast-multicast-flooded-unicast	I	Set interface ingress limit frame type to "accept broadcast, multicast, and flooded unicast frame"	switch(config)# interface fastEthernet 2 switch(config-if)# bandwidth type broadcast-multicast-flooded-unicast
bandwidth type broadcast-multicast	I	Set interface ingress limit frame type to "accept broadcast and multicast frame"	switch(config)# interface fastEthernet 2 switch(config-if)# bandwidth type broadcast-multicast

bandwidth type broadcast-only	I	Set interface ingress limit frame type to “only accept broadcast frame”	switch(config)# interface fastEthernet 2 switch(config-if)# bandwidth type broadcast-only
bandwidth in [Value]	I	Set interface input bandwidth. Rate Range is from 100 kbps to 102400 kbps or to 256000 kbps for giga ports, and zero means no limit.	switch(config)# interface fastEthernet 2 switch(config-if)# bandwidth in 100
bandwidth out [Value]		Set interface output bandwidth. Rate Range is from 100 kbps to 102400 kbps or to 256000 kbps for giga ports, and zero means no limit.	switch(config)# interface fastEthernet 2 switch(config-if)# bandwidth out 100
show bandwidth	I	Show interfaces bandwidth control	switch(config)# interface fastEthernet 2 switch(config-if)# show bandwidth
state [Enable Disable]	I	Use the state interface configuration command to specify the state mode of operation for Ethernet ports. Use the disable form of this command to disable the port.	switch(config)# interface fastEthernet 2 (config-if)# state Disable
show interface configuration	I	show interface configuration status	switch(config)# interface fastEthernet 2

			switch(config-if)# show interface configuration
show interface status	I	show interface actual status	switch(config)# interface fastEthernet 2 (config-if)# show interface status
show interface accounting	I	show interface statistic counter	switch(config)# interface fastEthernet 2 (config-if)# show interface accounting
no accounting	I	Clear interface accounting information	switch(config)# interface fastEthernet 2 switch(config-if)# no accounting

Trunk Commands Set

Commands	Level	Description	Example
aggregator priority [1~65535]	G	Set port group system priority	switch(config)# aggregator priority 22
aggregator activityport [Group ID] [Port Numbers]	G	Set activity port	switch(config)# aggregator activityport 2
aggregator group [GroupID] [Port-list] lACP workp [Workport]	G	Assign a trunk group with LACP active. [GroupID] :1~3 [Port-list]:Member port list, This parameter could be a port range(ex.1-4) or a port list separate by a comma(ex.2, 3, 6) [Workport]: The amount of work ports, this value could not be less than zero or be	switch(config)# aggregator group 1 1-4 lACP workp 2 or switch(config)# aggregator group 2 1,4,3 lACP workp 3

		large than the amount of member ports.	
aggregator group [GroupID] [Port-list] nolacp	G	Assign a static trunk group. [GroupID] :1~3 [Port-list]:Member port list, This parameter could be a port range(ex.1-4) or a port list separate by a comma(ex.2, 3, 6)	switch(config)# aggregator group 1 2-4 nolacp or switch(config)# aggregator group 1 3,1,2 nolacp
show aggregator	P	Show the information of trunk group	switch# show aggregator 1 or switch# show aggregator 2 or switch# show aggregator 3
no aggregator lacp [GroupID]	G	Disable the LACP function of trunk group	switch(config)# no aggregator lacp 1
no aggregator group [GroupID]	G	Remove a trunk group	switch(config)# no aggregator group 2

VLAN Commands Set

Commands	Level	Description	Example
vlan database	P	Enter VLAN configure mode	switch# vlan database
Vlanmode [portbase 802.1q gvrp]	V	To set switch VLAN mode.	switch(vlan)# vlanmode portbase or switch(vlan)# vlanmode 802.1q or switch(vlan)# vlanmode gvrp
no vlan	V	No VLAN	Switch(vlan)# no vlan
Ported based VLAN configuration			

vlan port-based grpname [Group Name] grp-id [GroupID] port [PortNumbers]	V	Add new port based VLAN	switch(vlan)# vlan port-based grpname test grp-id 2 port 2-4 or switch(vlan)# vlan port-based grpname test grp-id 2 port 2,3,4
show vlan [GroupID] or show vlan	V	Show VLAN information	switch(vlan)# show vlan 23
no vlan group [GroupID]	V	Delete port base group ID	switch(vlan)# no vlan group 2
IEEE 802.1Q VLAN			
vlan 8021q name [GroupName] vid [VID]	V	Change the name of VLAN group, if the group didn't exist, this command can't be applied.	switch(vlan)# vlan 8021q name test vid 22
vlan 8021q port [PortNumber] access-link untag [UntaggedVID]	V	Assign a access link for VLAN by port, if the port belong to a trunk group, this command can't be applied.	switch(vlan)# vlan 8021q port 3 access-link untag 33
vlan 8021q port [PortNumber] trunk-link tag [TaggedVID List]	V	Assign a trunk link for VLAN by port, if the port belong to a trunk group, this command can't be applied.	switch(vlan)# vlan 8021q port 3 trunk-link tag 2,3,6,99 or switch(vlan)# vlan 8021q port 3 trunk-link tag 3-20
vlan 8021q port [PortNumber] hybrid-link untag tag [UntaggedVID] [TaggedVID List]	V	Assign a hybrid link for VLAN by port, if the port belong to a trunk group, this command can't be applied.	switch(vlan)# vlan 8021q port 3 hybrid-link untag 4 tag 3,6,8 or switch(vlan)# vlan 8021q port 3 hybrid-link untag 5 tag 6-8
vlan 8021q trunk [PortNumber]	V	Assign a access link	switch(vlan)# vlan 8021q trunk 3

access-link untag [UntaggedVID]		for VLAN by trunk group	access-link untag 33
vlan 8021q trunk [PortNumber] trunk-link tag [TaggedVID List]	V	Assign a trunk link for VLAN by trunk group	switch(vlan)# vlan 8021q trunk 3 trunk-link tag 2,3,6,99 or switch(vlan)# vlan 8021q trunk 3 trunk-link tag 3-20
vlan 8021q trunk [PortNumber] hybrid-link untag tag [TaggedVID List]	V	Assign a hybrid link for VLAN by trunk group	switch(vlan)# vlan 8021q trunk 3 hybrid-link untag 4 tag 3,6,8 or switch(vlan)# vlan 8021q trunk 3 hybrid-link untag 5 tag 6-8
show vlan [GroupID] or show vlan	V	Show VLAN information	switch(vlan)# show vlan 23
no vlan group [GroupID]	V	Delete port base group ID	switch(vlan)# no vlan group 2

Spanning Tree Commands Set

Commands	Level	Description	Example
spanning-tree enable	G	Enable spanning tree	switch(config)# spanning-tree enable
spanning-tree priority [0~61440]	G	Configure spanning tree priority parameter	switch(config)# spanning-tree priority 32767
spanning-tree max-age [seconds]	G	Use the spanning-tree max-age global configuration command to change the interval between messages the spanning tree receives from the root switch. If a switch does not receive a bridge	switch(config)# spanning-tree max-age 15

		protocol data unit (BPDU) message from the root switch within this interval, it recomputed the Spanning Tree Protocol (STP) topology.	
spanning-tree hello-time [seconds]	G	Use the spanning-tree hello-time global configuration command to specify the interval between hello bridge protocol data units (BPDUs).	switch(config)# spanning-tree hello-time 3
spanning-tree forward-time [seconds]	G	Use the spanning-tree forward-time global configuration command to set the forwarding-time for the specified spanning-tree instances. The forwarding time determines how long each of the listening and learning states last before the port begins forwarding.	switch(config)# spanning-tree forward-time 20
stp-path-cost [1~200000000]	I	Use the spanning-tree cost interface configuration command to set the path cost for Spanning	switch(config)# interface fastEthernet 2 switch(config-if)# stp-path-cost 20

		Tree Protocol (STP) calculations. In the event of a loop, spanning tree considers the path cost when selecting an interface to place into the forwarding state.	
stp-path-priority [Port Priority]	I	Use the spanning-tree port-priority interface configuration command to configure a port priority that is used when two switches tie for position as the root switch.	switch(config)# interface fastEthernet 2 switch(config-if)# stp-path-priority 128
stp-admin-p2p [Auto True False]	I	Admin P2P of STP priority on this interface.	switch(config)# interface fastEthernet 2 switch(config-if)# stp-admin-p2p Auto
stp-admin-edge [True False]	I	Admin Edge of STP priority on this interface.	switch(config)# interface fastEthernet 2 switch(config-if)# stp-admin-edge True
stp-admin-non-stp [True False]	I	Admin NonSTP of STP priority on this interface.	switch(config)# interface fastEthernet 2 switch(config-if)# stp-admin-non-stp False
show spanning-tree	E	Displays a summary of the spanning-tree	switch> show spanning-tree

		states.	
no spanning-tree	G	Disable spanning-tree.	switch(config)# no spanning-tree

QOS Commands Set

Commands	Level	Description	Example
qos policy [weighted-fair strict]	G	Select QOS policy scheduling	switch(config)# qos policy weighted-fair
qos prioritytype [port-based cos-only tos-only cos-first tos-first]	G	Setting of QOS priority type	switch(config)# qos prioritytype
qos priority portbased [Port] [lowest low middle high]	G	Configure Port-based Priority	switch(config)# qos priority portbased 1 low
qos priority cos [Priority][lowest low middle high]	G	Configure COS Priority	switch(config)# qos priority cos 0 middle
qos priority tos [Priority][lowest low middle high]	G	Configure TOS Priority	switch(config)# qos priority tos 3 high
show qos	P	Displays the information of QoS configuration	Switch# show qos
no qos	G	Disable QoS function	switch(config)# no qos

IGMP Commands Set

Commands	Level	Description	Example
igmp enable	G	Enable IGMP snooping function	switch(config)# igmp enable
igmp-query auto	G	Set IGMP query to auto mode	switch(config)# igmp-query auto
igmp-query force	G	Set IGMP query to force mode	switch(config)# igmp-query force

show igmp configuration	P	Displays the details of an IGMP configuration.	switch# show igmp configuration
show igmp multi	P	Displays the details of an IGMP snooping entries.	switch# show igmp multi
no igmp	G	Disable IGMP snooping function	switch(config)# no igmp
no igmp-query	G	Disable IGMP query	switch# no igmp-query

Mac / Filter Table Commands Set

Commands	Level	Description	Example
mac-address-table static hwaddr [MAC]	I	Configure MAC address table of interface (static).	switch(config)# interface fastEthernet 2 switch(config-if)# mac-address-table static hwaddr 000012345678
mac-address-table filter hwaddr [MAC]	G	Configure MAC address table(filter)	switch(config)# mac-address-table filter hwaddr 000012348678
show mac-address-table	P	Show all MAC address table	switch# show mac-address-table
show mac-address-table static	P	Show static MAC address table	switch# show mac-address-table static
show mac-address-table filter	P	Show filter MAC address table.	switch# show mac-address-table filter
no mac-address-table static hwaddr [MAC]	I	Remove an entry of MAC address table of interface (static)	switch(config)# interface fastEthernet 2 switch(config-if)# no mac-address-table static hwaddr 000012345678
no mac-address-table filter hwaddr	G	Remove an entry of MAC address table	switch(config)# no mac-address-table filter hwaddr 000012348678

[MAC]		(filter)	
no mac-address-table	G	Remove dynamic entry of MAC address table	switch(config)# no mac-address-table

SNMP Commands Set

Commands	Level	Description	Example
snmp system-name [System Name]	G	Set SNMP agent system name	switch(config)# snmp system-name l2switch
snmp system-location [System Location]	G	Set SNMP agent system location	switch(config)# snmp system-location lab
snmp system-contact [System Contact]	G	Set SNMP agent system contact	switch(config)# snmp system-contact where
snmp agent-mode [v1v2c v3 v1v2cv3]	G	Select the agent mode of SNMP	switch(config)# snmp agent-mode v1v2cv3
snmp community-strings [Community] right [RO/RW]	G	Add SNMP community string.	switch(config)# snmp community-strings public right rw
snmp-server host [IP address] community [Community-string] trap-version [v1 v2c]	G	Configure SNMP server host information and community string	switch(config)# snmp-server host 192.168.1.50 community public trap-version v1 (remove) Switch(config)# no snmp-server host 192.168.1.50
snmpv3 context-name [Context Name]	G	Configure the context name	switch(config)# snmpv3 context-name Test
snmpv3 user [User Name] group [Group Name] password	G	Configure the userprofile for SNMPV3 agent. Privacy password could be empty.	switch(config)# snmpv3 user test01 group G1 password AuthPW PrivPW

[Authentication Password] [Privacy Password]			
snmpv3 access context-name [Context Name] group [Group Name] security-level [NoAuthNoPriv AuthNoPriv AuthPriv] match-rule [Exact Prifix] views [Read View Name] [Write View Name] [Notify View Name]	G	Configure the access table of SNMPV3 agent	switch(config)# snmpv3 access context-name Test group G1 security-level AuthPriv match-rule Exact views V1 V1 V1
snmpv3 mibview view [View Name] type [Excluded Included] sub-oid [OID]	G	Configure the mibview table of SNMPV3 agent	switch(config)# snmpv3 mibview view V1 type Excluded sub-oid 1.3.6.1
show snmp	P	Show SNMP configuration	switch# show snmp
no snmp community-strings [Community]	G	Remove the specified community.	switch(config)# no snmp community-strings public
no snmp-server host [Host-address]	G	Remove the SNMP server host.	switch(config)# no snmp-server 192.168.1.50
no snmpv3 user [User Name]	G	Remove specified user of SNMPv3 agent.	switch(config)# no snmpv3 user Test
no snmpv3 access context-name [Context	G	Remove specified access table of	switch(config)# no snmpv3 access context-name Test group G1

Name] group [Group Name] security-level [NoAuthNoPriv AuthNoPriv AuthPriv] match-rule [Exact Prifix] views [Read View Name] [Write View Name] [Notify View Name]		SNMPv3 agent.	security-level AuthPriv match-rule Exact views V1 V1 V1
no snmpv3 mibview view [View Name] type [Excluded Included] sub-oid [OID]	G	Remove specified mibview table of SNMPV3 agent.	switch(config)# no snmpv3 mibview view V1 type Excluded sub-oid 1.3.6.1

Port Mirroring Commands Set

Commands	Level	Description	Example
monitor [RX TX Both]	I	Configure source port of monitor function	switch(config)# interface fastEthernet 2 switch(config-if)# monitor RX
monitor rx [Port ID]	G	Set RX destination port of monitor function	switch(config)# monitor rx 2
monitor tx [Port ID]	G	Set TX destination port of monitor function	switch(config)# monitor tx 3
show monitor	P	Show port monitor information	switch# show monitor

show monitor	I	Show port monitor information	switch(config)# interface fastEthernet 2 switch(config-if)# show monitor
no monitor	I	Disable source port of monitor function	switch(config)# interface fastEthernet 2 switch(config-if)# no monitor

802.1x Commands Set

Commands	Level	Description	Example
8021x enable	G	Use the 802.1x global configuration command to enable 802.1x protocols.	switch(config)# 8021x enable
8021x system radiusip [IP address]	G	Use the 802.1x system radius IP global configuration command to change the radius server IP.	switch(config)# 8021x system radiusip 192.168.1.1
8021x system serverport [port ID]	G	Use the 802.1x system server port global configuration command to change the radius server port	switch(config)# 8021x system serverport 1815
8021x system accountport [port ID]	G	Use the 802.1x system account port global configuration command to change the accounting port	switch(config)# 8021x system accountport 1816
8021x system sharekey [ID]	G	Use the 802.1x system share key global configuration command to change the shared key value.	switch(config)# 8021x system sharekey 123456

8021x system nasid [words]	G	Use the 802.1x system nasid global configuration command to change the NAS ID	switch(config)# 8021x system nasid test1
8021x misc quietperiod [sec.]	G	Use the 802.1x misc quiet period global configuration command to specify the quiet period value of the switch.	switch(config)# 8021x misc quietperiod 10
8021x misc txperiod [sec.]	G	Use the 802.1x misc TX period global configuration command to set the TX period.	switch(config)# 8021x misc txperiod 5
8021x misc supportimeout [sec.]	G	Use the 802.1x misc supp timeout global configuration command to set the supplicant timeout.	switch(config)# 8021x misc supportimeout 20
8021x misc servertimeout [sec.]	G	Use the 802.1x misc server timeout global configuration command to set the server timeout.	switch(config)# 8021x misc servertimeout 20
8021x misc maxrequest [number]	G	Use the 802.1x misc max request global configuration command to set the MAX requests.	switch(config)# 8021x misc maxrequest 3
8021x misc reauthperiod [sec.]	G	Use the 802.1x misc reauth period global	switch(config)# 8021x misc reauthperiod 3000

		configuration command to set the reauth period.	
8021x portstate [disable reject accept authorize]	I	Use the 802.1x port state interface configuration command to set the state of the selected port.	switch(config)# interface fastethernet 3 switch(config-if)# 8021x portstate accept
show 8021x	E	Displays a summary of the 802.1x properties and also the port sates.	switch> show 8021x
no 8021x	G	Disable 802.1x function	switch(config)# no 8021x

TFTP Commands Set

Commands	Level	Description	Defaults Example
backup flash:backup_cfg	G	Save configuration to TFTP and need to specify the IP of TFTP server and the file name of image.	switch(config)# backup flash:backup_cfg
restore flash:restore_cfg	G	Get configuration from TFTP server and need to specify the IP of TFTP server and the file name of image.	switch(config)# restore flash:restore_cfg
upgrade flash:upgrade_fw	G	Upgrade firmware by TFTP and need to specify the IP of TFTP server and the file name of image.	switch(config)# upgrade lash:upgrade_fw

SystemLog, SMTP and Event Commands Set

Commands	Level	Description	Example
systemlog ip [IP address]	G	Set System log server IP address.	switch(config)# systemlog ip 192.168.1.100
systemlog mode [client server both]	G	Specified the log mode	switch(config)# systemlog mode both
show systemlog	E	Displays system log.	Switch> show systemlog
show systemlog	P	Show system log client & server information	switch# show systemlog
no systemlog	G	Disable systemlog functon	switch(config)# no systemlog
smtp enable	G	Enable SMTP function	switch(config)# smtp enable
smtp serverip [IP address]	G	Configure SMTP server IP	switch(config)# smtp serverip 192.168.1.5
smtp authentication	G	Enable SMTP authentication	switch(config)# smtp authentication
smtp account [account]	G	Configure authentication account	switch(config)# smtp account John
smtp password [password]	G	Configure authentication password	switch(config)# smtp password 1234
smtp rcptemail [Index] [Email address]	G	Configure Rcpt e-mail Address	switch(config)# smtp rcptemail 1 <u>Alert@test.com</u>
show smtp	P	Show the information of SMTP	switch# show smtp
no smtp	G	Disable SMTP function	switch(config)# no smtp
event device-cold-start [Systemlog SMTP Both]	G	Set cold start event type	switch(config)# event device-cold-start both
event authentication-failure	G	Set Authentication failure event type	switch(config)# event authentication-failure both

[Systemlog SMTP Both]			
event ring-topology-change [Systemlog SMTP Both]	G	Set X-ring topology changed event type	switch(config)# event ring-topology-change both
event systemlog [Link-UP Link-Down Both]	I	Set port event for system log	switch(config)# interface fastethernet 3 switch(config-if)# event systemlog both
event smtp [Link-UP Link-Down Both]	I	Set port event for SMTP	switch(config)# interface fastethernet 3 switch(config-if)# event smtp both
show event	P	Show event selection	switch# show event
no event device-cold-start	G	Disable cold start event type	switch(config)# no event device-cold-start
no event authentication-failure	G	Disable Authentication failure event typ	switch(config)# no event authentication-failure
no event X-ring-topology-change	G	Disable X-ring topology changed event type	switch(config)# no event X-ring-topology-change
no event systemlog	I	Disable port event for system log	switch(config)# interface fastethernet 3 switch(config-if)# no event systemlog
no event smtp	I	Disable port event for SMTP	switch(config)# interface fastethernet 3 switch(config-if)# no event smtp
show systemlog	P	Show system log client & server information	switch# show systemlog

SNTP Commands Set

Commands	Level	Description	Example
sntp enable	G	Enable SNTP function	switch(config)# sntp enable

sntp daylight	G	Enable daylight saving time, if SNTP function is inactive, this command can't be applied.	switch(config)# sntp daylight
sntp daylight-period [Start time] [End time]	G	Set period of daylight saving time, if SNTP function is inactive, this command can't be applied. Parameter format: [yyyymmdd-hh:mm]	switch(config)# sntp daylight-period 20060101-01:01 20060202-01:01
sntp daylight-offset [Minute]	G	Set offset of daylight saving time, if SNTP function is inactive, this command can't be applied.	switch(config)# sntp daylight-offset 3
sntp ip [IP]	G	Set SNTP server IP, if SNTP function is inactive, this command can't be applied.	switch(config)# sntp ip 192.169.1.1
sntp timezone [Timezone]	G	Set timezone index, use "show sntp timzezone" command to get more information of index number	switch(config)# sntp timezone 22
show sntp	P	Show SNTP information	switch# show sntp
show sntp timezone	P	Show index number of time zone list	switch# show sntp timezone
no sntp	G	Disable SNTP function	switch(config)# no sntp

no sntp daylight	G	Disable daylight saving time	switch(config)#no sntp daylight
-------------------------	----------	------------------------------	---------------------------------

X-ring Commands Set

Commands	Level	Description	Example
Xring enable	G	Enable X-ring	switch(config)#Xring enable
Xring master	G	Enable ring master	switch(config)#Xring master
Xring couplering	G	Enable couple ring	switch(config)#Xring couplering
Xring dualhoming	G	Enable dual homing	switch(config)#Xring dualhoming
Xring ringport [1st Ring Port] [2nd Ring Port]	G	Configure 1st/2nd Ring Port	switch(config)#Xring ringport 7 8
Xring couplingport [Coupling Port]	G	Configure Coupling Port	switch(config)#Xring couplingport 1
Xring controlport [Control Port]	G	Configure Control Port	switch(config)#Xring controlport 2
Xring homingport [Dual Homing Port]	G	Configure Dual Homing Port	switch(config)#Xring homingport 3
show Xring	P	Show the information of X - Ring	switch#show Xring
no Xring	G	Disable X-ring	switch(config)#no X ring
no Xring master	G	Disable ring master	switch(config)# no Xring master
no Xring couplering	G	Disable couple ring	switch(config)# no Xring couplering
no Xring dualhoming	G	Disable dual homing	switch(config)# no Xring dualhoming

Web-Based Management

This section introduces the configuration and functions of the Web-Based management.

About Web-based Management

There is an embedded HTML web site residing in flash memory on CPU board of the switch, which offers advanced management features and allows users to manage the switch from anywhere on the network through a standard browser such as Microsoft Internet Explorer.

The Web-Based Management supports Internet Explorer 6.0 or later version. And, it is applied for Java Applets for reducing network bandwidth consumption, enhance access speed and present an easy viewing screen.

Preparing for Web Management

Before using the web management, install the industrial switch on the network and make sure that any one of the PCs on the network can connect with the industrial switch through the web browser. The industrial switch default value of IP, subnet mask, username and password are listed as below:

- IP Address: **192.168.16.1**
- Subnet Mask: **255.255.255.0**
- Default Gateway: **192.168.16.254**
- User Name: **root**
- Password: **root**

System Login

1. Launch the Internet Explorer on the PC
2. Key in “http:// +” the IP address of the switch”, and then Press “**Enter**”.



3. The login screen will appear right after
4. Key in the user name and password. The default user name and password are the same as ‘**root**’.
5. Press ‘**Enter**’ or click **OK** button, and then the home screen of the Web-based management appears.



System Information

Assign the system name and location and view the system information

- **System Name:** Assign the system name of the switch (The maximum length is 64 bytes)
- **System Description:** Describes the switch.
- **System Location:** Assign the switch physical location (The maximum length is 64 bytes).
- **System Contact:** Enter the name of contact person or organization.
- **Firmware Version:** Displays the switch's firmware version
- **Kernel Version:** Displays the kernel software version
- **MAC Address:** Displays the unique hardware address assigned by manufacturer (default)
- And then, click button.

System Information

System Name	<input type="text"/>
System Description	7+3G port Industrial Managed Redundant Gigabit Ethernet Swit
System Location	<input type="text"/>
System Contact	<input type="text"/>

Firmware Version	v1.04
Kernel Version	v1.57
MAC Address	001122334455

System information interface

IP Configuration

User can configure the IP Settings and DHCP client function in here.

- **DHCP Client:** Enable or disable the DHCP client function. When DHCP client function is enabled, the industrial switch will be assigned an IP address from the network DHCP server. The default IP address will be replaced by the assigned IP address on DHCP server. After user click **Apply** button, a popup dialog shows up. It

is to inform the user that when the DHCP client is enabled, the current IP will lose and user should find the new IP on the DHCP server.

- **IP Address:** Assign the IP address that the network is using. If DHCP client function is enabled, and then the user doesn't need to assign the IP address. And, the network DHCP server will assign the IP address displaying in this column for the industrial switch. The default IP is 192.168.16.1.
- **Subnet Mask:** Assign the subnet mask to the IP address. If DHCP client function is enabled, and then the user does not need to assign the subnet mask.
- **Gateway:** Assign the network gateway for the industrial switch. The default gateway is 192.168.16.254.
- **DNS1:** Assign the primary DNS IP address.
- **DNS2:** Assign the secondary DNS IP address.
- And then, click

IP Configuration

DHCP Client : ▾

IP Address	192.168.16.1
Subnet Mask	255.255.255.0
Gateway	192.168.16.254
DNS1	0.0.0.0
DNS2	0.0.0.0

IP configuration interface

DHCP Server – System configuration

DHCP is the abbreviation of Dynamic Host Configuration Protocol that is a protocol for assigning dynamic IP addresses to devices on a network. With dynamic addressing, a device can have a different IP address every time it connects to the network. In some systems, the device's IP address can even change while it is still connected. DHCP also supports a mix of static and dynamic IP addresses. Dynamic addressing simplifies

network administration because the software keeps track of IP addresses rather than requiring an administrator to manage the task. This means that a new computer can be added to a network without the hassle of manually assigning it a unique IP address.

The system provides the DHCP server function. Enable the DHCP server function, the switch system will be a DHCP server.

- **DHCP Server:** Enable or Disable the DHCP Server function. Enable—the switch will be the DHCP server on your local network.
- **Low IP Address:** Type in an IP address. Low IP address is the beginning of the dynamic IP range. For example, dynamic IP is in the range between 192.168.1.100 ~ 192.168.1.200. In contrast, 192.168.1.100 is the Low IP address.
- **High IP Address:** Type in an IP address. High IP address is the end of the dynamic IP range. For example, dynamic IP is in the range between 192.168.1.100 ~ 192.168.1.200. In contrast, 192.168.1.200 is the High IP address.
- **Subnet Mask:** Type in the subnet mask of the IP configuration.
- **Gateway:** Type in the IP address of the gateway in your network.
- **DNS:** Type in the Domain Name Server IP Address in your network.
- **Lease Time (sec):** It is the time period that system will reset the dynamic IP assignment to ensure the dynamic IP will not be occupied for a long time or the server doesn't know that the dynamic IP is idle.
- And then, click

DHCP Server - System Configuration

System Configuration	Client Entries	Port and IP Binding
----------------------	----------------	---------------------

DHCP Server :

Low IP Address	<input type="text" value="192.168.16.100"/>
High IP Address	<input type="text" value="192.168.16.200"/>
Subnet Mask	<input type="text" value="255.255.255.0"/>
Gateway	<input type="text" value="192.168.16.254"/>
DNS	<input type="text" value="0.0.0.0"/>
Lease Time (sec)	<input type="text" value="86400"/>

DHCP Server Configuration interface

DHCP Server – Client Entries

When the DHCP server function is active, the system will collect the DHCP client information and displays it at this tab.

DHCP Server - Client Entries

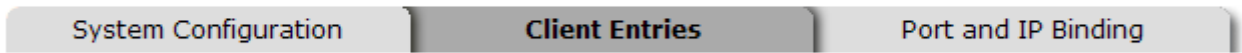

IP addr	Client ID	Type	Status	Lease
---------	-----------	------	--------	-------

DHCP Client Entries interface

DHCP Server - Port and IP Bindings

Assign the dynamic IP address to the port. When the device is connecting to the port and asks for IP assigning, the system will assign the IP address that has been assigned before to the connected device.

DHCP Server - Port and IP Binding

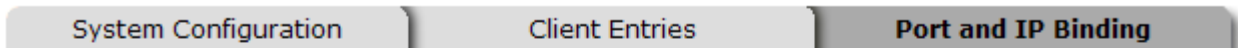

Port	IP
Port.01	0.0.0.0
Port.02	0.0.0.0
Port.03	0.0.0.0
Port.04	0.0.0.0
Port.05	0.0.0.0
Port.06	0.0.0.0
Port.07	0.0.0.0
Port.08	0.0.0.0
Port.09	0.0.0.0
Port.10	0.0.0.0

Apply Help

Port and IP Bindings interface

TFTP - Update Firmware

It provides the functions that allow user to update the switch firmware. Before updating, make sure the TFTP server is ready and the firmware image is located on the TFTP server.

1. **TFTP Server IP Address:** Type in your TFTP server IP.
2. **Firmware File Name:** Type in the name of firmware image.
3. Click .

TFTP - Update Firmware

Update Firmware	Restore Configuration	Backup Configuration
TFTP Server IP Address	<input type="text" value="192.168.16.2"/>	
Firmware File Name	<input type="text" value="image.bin"/>	
<input type="button" value="Apply"/> <input type="button" value="Help"/>		

Update Firmware interface

TFTP – Restore Configuration

You can restore the configuration from TFTP server. Before doing that, you must put the image file on TFTP server first and the switch will download back the flash image.

1. **TFTP Server IP Address:** Type in the TFTP server IP.
2. **Restore File Name:** Type in the correct file name for restoring.
3. Click .

TFTP - Restore Configuration

Update Firmware	Restore Configuration	Backup Configuration
TFTP Server IP Address	<input type="text" value="192.168.16.2"/>	
Restore File Name	<input type="text" value="data.bin"/>	
<input type="button" value="Apply"/> <input type="button" value="Help"/>		

Restore Configuration interface

TFTP - Backup Configuration

You can save the current configuration from flash ROM to TFTP server for restoring later.

1. **TFTP Server IP Address:** Type in the TFTP server IP.
2. **Backup File Name:** Type in the file name.
3. Click .

TFTP - Backup Configuration

Update Firmware	Restore Configuration	Backup Configuration
TFTP Server IP Address	<input type="text" value="192.168.16.2"/>	
Backup File Name	<input type="text" value="data.bin"/>	
<input type="button" value="Apply"/> <input type="button" value="Help"/>		

Backup Configuration interface

System Event Log – Syslog Configuration

Configure the system event mode to collect system log.

1. **Syslog Client Mode:** Select the system log mode—**Client Only**, **Server Only**, or **Both**.
2. **System Log Server IP Address:** Assign the system log server IP.
3. When Syslog Client Mode is set as **Client Only**, the system event log will only be sent to the client which has logged in on the switch. When Syslog Client Mode is set as **Server Only**, the system log will only be sent to the syslog server and you have to type the IP address in the Syslog Server IP Address column. If the Syslog Client Mode is set as **Both**, the system log will be sent to client and server.
4. Click to refresh the events log.
5. Click to clear all current events log.

5. After configuring, Click **Apply**.

System Event Log - Syslog Configuration

Syslog Client Mode	Both	Apply
Syslog Server IP Address	192.168.16.200	

```
3: Jan 1 00:02:53 : System Log Server IP: 192.168.16.200
2: Jan 1 00:02:53 : System Log Enable!
1: Jan 1 00:02:18 : Clear System Log Table!
```

Page.1
Page.2
Page.3
Page.4
Page.5
Page.6
Page.7
Page.8
Page.9
Page.10
Page.1

Reload	Clear	Help
---------------	--------------	-------------

Syslog Configuration interface

System Event Log - SMTP Configuration

You can set up the mail server IP, mail account, password, and forwarded email account for receiving the event alert.

1. **Email Alert:** Enable or disable the email alert function.
2. **SMTP Server IP:** Set up the mail server IP address (when **Email Alert** enabled, this function will then be available).
3. **Sender:** Type in an alias of the switch in complete email address format, e.g. switch101@123.com, to identify where the event log comes from.

4. **Authentication:** Tick the checkbox to enable this function, configuring the email account and password for authentication (when **Email Alert** enabled, this function will then be available).
5. **Mail Account:** Set up the email account, e.g. [johnadmin](#), to receive the alert. It must be an existing email account on the mail server, which you had set up in **SMTP Server IP Address** column.
6. **Password:** Type in the password to the email account.
7. **Confirm Password:** Reconfirm the password.
8. **Rcpt e-mail Address 1 ~ 6:** You can also assign up to 6 e-mail accounts to receive the alert.
9. Click button.

System Event Log - SMTP Configuration

Syslog Configuration	SMTP Configuration	Event Configuration
E-mail Alert: <input type="button" value="Enable"/>		
SMTP Server IP Address :	<input type="text" value="192.168.16.5"/>	
Sender :	<input type="text" value="switch101@123.com"/>	
<input checked="" type="checkbox"/> Authentication		
Mail Account :	<input type="text" value="johnadmin"/>	
Password :	<input type="password" value="••••"/>	
Confirm Password :	<input type="password" value="••••"/>	
Rcpt e-mail Address 1 :	<input type="text" value="supervisor@123.com"/>	
Rcpt e-mail Address 2 :	<input type="text"/>	
Rcpt e-mail Address 3 :	<input type="text"/>	
Rcpt e-mail Address 4 :	<input type="text"/>	
Rcpt e-mail Address 5 :	<input type="text"/>	
Rcpt e-mail Address 6 :	<input type="text"/>	
<input type="button" value="Apply"/> <input type="button" value="Help"/>		

SMTP Configuration interface

System Event Log - Event Configuration

When the **Syslog/SMTP** checkbox is marked, the event log will be sent to system log server/SMTP server. Also, per port log (link up, link down, and both) events can be sent to the system log server/SMTP server with the respective checkbox ticked. After configuring, click to have the setting taken effect.

- **System event selection:** There are 4 event types—Device cold start, Device warm start, Authentication Failure, and X-ring topology change. Before you can tick the checkbox of each event type, the Syslog Client Mode column on the Syslog Configuration tab/E-mail Alert column on the SMTP Configuration tab must be enabled first.
 - **Device cold start:** When the device executes cold start action, the system will issue a log event.
 - **Device warm start:** When the device executes warm start, the system will issue a log event.
 - **Authentication Failure:** When the SNMP authentication fails, the system will issue a log event.
 - **X-ring topology change:** When the X-ring topology has changed, the system will issue a log event.

- **Port event selection:** Also, before the drop-down menu items are available, the Syslog Client Mode column on the Syslog Configuration tab and the E-mail Alert column on the SMTP Configuration tab must be enabled first. Those drop-down menu items have 3 selections—Link UP, Link Down, and Link UP & Link Down. Disable means no event will be sent to the system log server/SMTP server.
 - **Link UP:** The system will issue a log message when port connection is up only.
 - **Link Down:** The system will issue a log message when port connection is down only.
 - **Link UP & Link Down:** The system will issue a log message when port connection is up and down.

System Event Log - Event Configuration

Syslog Configuration

SMTP Configuration

Event Configuration

System event selection

Event Type	Syslog	SMTP
Device cold start	<input type="checkbox"/>	<input checked="" type="checkbox"/>
Device warm start	<input checked="" type="checkbox"/>	<input type="checkbox"/>
Authentication failure	<input type="checkbox"/>	<input checked="" type="checkbox"/>
X-Ring topology change	<input checked="" type="checkbox"/>	<input checked="" type="checkbox"/>

Port event selection

Port	Syslog	SMTP
Port.01	Disable	Disable
Port.02	Disable	Disable
Port.03	Link Up Link Down Link Up & Link Down	Disable
Port.04	Disable	Disable
Port.05	Disable	Disable
Port.06	Disable	Disable
Port.07	Disable	Disable
Port.08	Disable	Disable
Port.09	Disable	Disable
Port.10	Disable	Disable

Apply Help

Event Configuration interface

Fault Relay Alarm

- **Power Failure:** Tick the checkbox to enable the function of lighting up the **FAULT** LED on the panel when power fails.
- **Port Link Down/Broken:** Tick the checkbox to enable the function of lighting up **FAULT** LED on the panel when Ports' states are link down or broken.

Fault Relay Alarm

Power Failure	
<input checked="" type="checkbox"/> Power 1	<input checked="" type="checkbox"/> Power 2
Port Link Down/Broken	
<input type="checkbox"/> Port 1	<input type="checkbox"/> Port 2
<input type="checkbox"/> Port 3	<input type="checkbox"/> Port 4
<input type="checkbox"/> Port 5	<input checked="" type="checkbox"/> Port 6
<input type="checkbox"/> Port 7	<input type="checkbox"/> Port 8
<input type="checkbox"/> Port 9	<input type="checkbox"/> Port 10
<input type="button" value="Apply"/>	

Fault Relay Alarm interface

SNTP Configuration

You can configure the SNTP (Simple Network Time Protocol) settings. The SNTP allows you to synchronize switch clocks in the Internet.

1. **SNTP Client:** Enable/disable SNTP function to get the time from the SNTP server.
2. **Daylight Saving Time:** Enable/disable daylight saving time function. When daylight saving time is enabled, you need to configure the daylight saving time period.
3. **UTC Timezone:** Set the switch location time zone. The following table lists the different location time zone for your reference.

Local Time Zone	Conversion from UTC	Time at 12:00 UTC
November Time Zone	- 1 hour	11am
Oscar Time Zone	-2 hours	10 am
ADT - Atlantic Daylight	-3 hours	9 am
AST - Atlantic Standard EDT - Eastern Daylight	-4 hours	8 am
EST - Eastern Standard	-5 hours	7 am

CDT - Central Daylight		
CST - Central Standard MDT - Mountain Daylight	-6 hours	6 am
MST - Mountain Standard PDT - Pacific Daylight	-7 hours	5 am
PST - Pacific Standard ADT - Alaskan Daylight	-8 hours	4 am
ALA - Alaskan Standard	-9 hours	3 am
HAW - Hawaiian Standard	-10 hours	2 am
Nome, Alaska	-11 hours	1 am
CET - Central European FWT - French Winter MET - Middle European MEWT - Middle European Winter SWT - Swedish Winter	+1 hour	1 pm
EET - Eastern European, USSR Zone 1	+2 hours	2 pm
BT - Baghdad, USSR Zone 2	+3 hours	3 pm
ZP4 - USSR Zone 3	+4 hours	4 pm
ZP5 - USSR Zone 4	+5 hours	5 pm
ZP6 - USSR Zone 5	+6 hours	6 pm
WAST - West Australian Standard	+7 hours	7 pm
CCT - China Coast, USSR Zone 7	+8 hours	8 pm

JST - Japan Standard, USSR Zone 8	+9 hours	9 pm
EAST - East Australian Standard GST Guam Standard, USSR Zone 9	+10 hours	10 pm
IDLE - International Date Line NZST - New Zealand Standard NZT - New Zealand	+12 hours	Midnight

4. **SNTP Sever URL:** Set the SNTP server IP address.
5. **Switch Timer:** Displays the current time of the switch.
6. **Daylight Saving Period:** Set up the Daylight Saving beginning time and Daylight Saving ending time. Both will be different in every year.
7. **Daylight Saving Offset (mins):** For non-US and European countries, specify the amount of time for day light savings.
8. Click .

SNTP Configuration

SNTP Client : ▾

Daylight Saving Time : ▾

UTC Timezone	<input type="text" value="(GMT+08:00)Taipei"/> ▾	
SNTP Server URL	<input type="text" value="76.168.30.201"/>	
Switch Timer	<input type="text" value="Monday, September 03, 2007 4:35:"/>	
Daylight Saving Period	<input type="text" value="20040101 00:0"/>	<input type="text" value="20040101 00:0"/>
Daylight Saving Offset(mins)	<input type="text" value="0"/>	

SNTP Configuration interface

IP Security

IP security function allows the user to assign 10 specific IP addresses that have permission to access the switch through the web browser for the securing switch management.

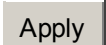
- **IP Security Mode:** When this option is in **Enable** mode, the **Enable HTTP Server** and **Enable Telnet Server** checkboxes will then be available.
- **Enable HTTP Server:** When this checkbox is ticked, the IP addresses among Security IP1 ~ IP10 will be allowed to access this switch via HTTP service.
- **Enable Telnet Server:** When this checkbox is ticked, the IP addresses among Security IP1 ~ IP10 will be allowed to access this switch via telnet service.
- **Security IP 1 ~ 10:** The system allows the user to assign up to 10 specific IP addresses for access security. Only these 10 IP addresses can access and manage the switch through the HTTP/Telnet service.
- And then, click  button to apply the configuration.

[NOTE] Remember to execute the “Save Configuration” action, otherwise the new configuration will lose when the switch powers off.

IP Security

IP Security Mode:

<input checked="" type="checkbox"/> Enable HTTP Server
<input checked="" type="checkbox"/> Enable Telnet Server

Security IP1	<input type="text" value="192.168.16.77"/>
Security IP2	<input type="text" value="192.168.16.89"/>
Security IP3	<input type="text" value="192.168.16.120"/>
Security IP4	<input type="text" value="0.0.0.0"/>
Security IP5	<input type="text" value="0.0.0.0"/>
Security IP6	<input type="text" value="0.0.0.0"/>
Security IP7	<input type="text" value="0.0.0.0"/>
Security IP8	<input type="text" value="0.0.0.0"/>
Security IP9	<input type="text" value="0.0.0.0"/>
Security IP10	<input type="text" value="0.0.0.0"/>

IP Security interface

User Authentication

Change web management login user name and password for the management security issue.

1. **User name:** Type in the new user name (The default is 'root')
2. **Password:** Type in the new password (The default is 'root')
3. **Confirm password:** Re-type the new password
4. And then, click

User Authentication

User Name :	<input type="text" value="root"/>
New Password :	<input type="password" value="...."/>
Confirm Password :	<input type="password" value="...."/>

User Authentication interface

Digital Input/Output

The 7 10/100TX + 3 10/100/1000T/100/1000 SFP Combo w/ X-Ring L2 Managed Industrial Switch contains two digital outputs and two digital inputs. Outputs are open-collector transistor switches that may be controlled by the host computer. They provide messages, which can be applied to heaters, pumps, and other electrical equipment. The digital inputs may be read by the host computer and used to sense the state of a remote digital signal.

- When **First/Second Digital Input/Output** function is enabled, First Digital Input/Output and Second Digital Input/Output will then be available respectively.
- **Digital Input:** Choose the transition type to trigger DI0/DI1.
 - **Low→High:** Having focused this radio button, DI0/DI1 will only report the status when the external device's voltage changes from low to high.
 - **High→Low:** Having focused this radio button, DI0/DI1 will only report the status when the external device's voltage changes from high to low.
- **Event description:** Please fill in the description for the event.
- **Action:** Tick the check boxes to decide whether or not to send the events via Syslog, SMTP, or SNMP Trap.

Digital Input/Output

First Digital Input/Output :

Digital Input	<input checked="" type="radio"/> Low->High <input type="radio"/> High->Low
Event description	<input type="text" value="Test"/>
Action	<input checked="" type="checkbox"/> Syslog <input checked="" type="checkbox"/> SMTP <input checked="" type="checkbox"/> SNMP Trap

Second Digital Input/Output :

Digital Input	<input type="radio"/> Low->High <input checked="" type="radio"/> High->Low
Event description	<input type="text"/>
Action	<input checked="" type="checkbox"/> Syslog <input checked="" type="checkbox"/> SMTP <input checked="" type="checkbox"/> SNMP Trap

Digital Input/Output interface

Port Statistics

The following information provides the current port statistic information.

- **Port:** Displays the port number.
- **Type:** Displays the media type of the port.
- **Link:** The status of linking—‘Up’ or ‘Down’.
- **State:** The user can set the state of the port as ‘Enable’ or ‘Disable’ via Port Control. When the state is disabled, the port will not transmit or receive any packet.
- **Tx Good Packet:** The counts of transmitting good packets via this port.
- **Tx Bad Packet:** The counts of transmitting bad packets (including undersize [less than 64 bytes], oversize, CRC Align errors, fragments and jabbers packets) via this port.
- **Rx Good Packet:** The counts of receiving good packets via this port.
- **Rx Bad Packet:** The counts of receiving good packets (including undersize [less than 64 bytes], oversize, CRC error, fragments and jabbers) via this port.
- **Tx Abort Packet:** The aborted packet while transmitting.
- **Packet Collision:** The counts of collision packet.
- **Packet Dropped:** The counts of dropped packet.
- **Rx Bcast Packet:** The counts of broadcast packet.
- **Rx Mcast Packet:** The counts of multicast packet.
- Click button to clean all counts.

Port Statistics

Port	Type	Link	State	Tx Good Packet	Tx Bad Packet	Rx Good Packet	Rx Bad Packet	Tx Abort Packet	Packet Collision	Packet Dropped	RX Bcast Packet	RX Mcast Packet
Port.01	100TX	Down	Enable	0	0	0	0	0	0	0	0	0
Port.02	100TX	Down	Enable	0	0	0	0	0	0	0	0	0
Port.03	100TX	Up	Enable	645	0	5957	0	0	2	0	3717	884
Port.04	100TX	Down	Enable	0	0	0	0	0	0	0	0	0
Port.05	100TX	Down	Enable	0	0	0	0	0	0	0	0	0
Port.06	100TX	Down	Enable	0	0	0	0	0	0	0	0	0
Port.07	1GTX/mGBIC	Down	Enable	0	0	0	0	0	0	0	0	0
Port.08	100TX	Down	Enable	0	0	0	0	0	0	0	0	0
Port.09	1GTX/mGBIC	Down	Enable	0	0	0	0	0	0	0	0	0
Port.10	1GTX/mGBIC	Down	Enable	0	0	0	0	0	0	0	0	0

Port Statistics interface

Port Control

In Port control, you can view and set the operation mode of each port.

1. **Port:** Select the port that you want to configure.
2. **State:** Current port status. The port can be set to disable or enable mode. If the port state is set as 'Disable', it will not receive or transmit any packet.
3. **Negotiation:** Auto and Force. Being set as Auto, the speed and duplex mode are negotiated automatically. When you set it as Force, you have to assign the speed and duplex mode manually.
4. **Speed:** It is available for selecting when the Negotiation column is set as Force. When the Negotiation column is set as Auto, this column is read only.
5. **Duplex:** It is available for selecting when the Negotiation column is set as Force. When the Negotiation column is set as Auto, this column is read only.
6. **Flow Control:** Set flow control function as Enable or Disable. When enabled, once the device exceed the input data rate of another device as a result the receiving device will send a PAUSE frame which halts the transmission of the sender for a specified period of time. When disabled, the receiving device will drop the packet if too much to process.
7. **Security:** Once the Security selection is set as 'On', any access from the device which connects to this port will be blocked unless the MAC address of the device is included in the static MAC address table. See the segment of Static MAC Table.
8. Click button to make the configuration effective.

Port Control

Port	State	Negotiation	Speed	Duplex	Flow Control	Security
Port.01						
Port.02	Enable	Auto	100	Full	Enable	Off
Port.03						
Port.04						

Port	Group ID	Type	Link	State	Negotiation	Speed Duplex		Flow Control		Security
						Config	Actual	Config	Actual	
Port.01	N/A	100TX	Down	Enable	Auto	100 Full	N/A	Enable	N/A	OFF
Port.02	N/A	100TX	Down	Enable	Auto	100 Full	N/A	Enable	N/A	OFF
Port.03	N/A	100TX	Up	Enable	Auto	100 Full	100 Half	Enable	OFF	OFF
Port.04	N/A	100TX	Down	Enable	Auto	100 Full	N/A	Enable	N/A	OFF
Port.05	N/A	100TX	Down	Enable	Auto	100 Full	N/A	Enable	N/A	OFF
Port.06	N/A	100TX	Down	Enable	Auto	100 Full	N/A	Enable	N/A	OFF
Port.07	N/A	1GTX/mGBIC	Down	Enable	Auto	1G Full	N/A	Enable	N/A	OFF
Port.08	N/A	100TX	Down	Enable	Auto	100 Full	N/A	Enable	N/A	OFF
Port.09	N/A	1GTX/mGBIC	Down	Enable	Auto	1G Full	N/A	Enable	N/A	OFF
Port.10	N/A	1GTX/mGBIC	Down	Enable	Auto	1G Full	N/A	Enable	N/A	OFF

Port Control interface

Port Trunk

Port trunk allows multiple links to be bundled together and act as a single physical link for increased throughput. It provides load balancing, and redundancy of links in a switched inter-network. Actually, the link does not have an inherent total bandwidth equal to the sum of its component physical links. Traffic in a trunk is distributed across an individual link within the trunk in a deterministic method that called a hash algorithm. Traffic pattern on the network should be considered carefully before applying it. When a proper hash algorithm is used, traffic is kind of randomly decided to be transmitted across either link within the trunk and load balancing will be seen.

Aggregator setting

1. **System Priority:** A value which is used to identify the active LACP. The switch with the lowest value has the highest priority and is selected as the active LACP.

2. **Group ID:** There are four trunk groups to be selected. Choose the "**Group ID**" and click button.
3. **LACP:** When enabled, the trunk group is using LACP. A port which joins an LACP trunk group has to make an agreement with its member ports first. When disabled, the trunk group is a static trunk group. The advantage of having the LACP disabled is that a port joins the trunk group without any handshaking with its member ports. But member ports won't know that they should be aggregated together to form a logic trunk group.
4. **Work ports:** This column field allows the user to type in the total number of active port up to four. With LACP static trunk group, e.g. you assign four ports to be the members of a trunk group whose work ports column field is set as two; the exceed ports are standby (the **LACP State Activity** will show 'Passive' on the tab of **State Activity**) and can be aggregated if work ports fail. If it is a static trunk group, the number of work ports must equal the total number of group member ports.
5. Select the ports to join the trunk group. The system allows four ports maximum to be aggregated in a trunk group. Click button to add the port which is focused to the left field. To remove unwanted ports, select the port and click button.
6. When LACP enabled, you can configure LACP Active/Passive status for each port on State Activity page.
7. Click button.
8. Use button to delete Trunk Group. Select the Group ID and click button.

Port Trunk - Aggregator Setting

Aggregator Setting			Aggregator Information			State Activity		
System Priority								
1								
Group ID	Trunk.1	Select						
Lacp	Enable							
Work Ports	4							
Port.01 Port.02 Port.03 Port.04	<<Add	Remove>>	Port.05 Port.06 Port.07 Port.08 Port.09 Port.10					
Apply Delete Help								

Notice: The trunk function do not support GVRP and X-Ring.

Port Trunk—Aggregator Setting interface (four ports are added to the left field with LACP enabled)

Aggregator Information

When you have setup the aggregator setting with LACP disabled, you will see the local static trunk group information in here.

1. **Group Key:** Displays the trunk group ID.
2. **Port Member:** Displays the members of this static trunk group.

System Priority		
1		
Group ID	Trunk.1	Select
Lacp	Disable	
Work Ports	2	
Port.01 Port.02	<<Add Remove>>	Port.03 Port.04 Port.05 Port.06 Port.07 Port.08 Port.09 Port.10
Apply Delete Help		

Notice: The trunk function do not support GVRP and X-Ring.

Port Trunk—Aggregator Setting interface (two ports are added to the left field with LACP disable)

Port Trunk - Aggregator Information

Aggregator Setting	Aggregator Information	State Activity
--------------------	-------------------------------	----------------

Static Trunking Group	
Group Key	1
Port Member	1 2

Port Trunk – Aggregator Information interface

State Activity

Having set up the LACP aggregator on the tab of Aggregator Setting, you can configure the state activity for the members of the LACP trunk group. You can tick or cancel the checkbox beside the state display. When you remove the tick mark to the port and click

Apply button, the port state activity will change to **Passive**.

- **Active:** The port automatically sends LACP protocol packets.
- **Passive:** The port does not automatically send LACP protocol packets, and responds only if it receives LACP protocol packets from the opposite device.

-
- [NOTE]**
1. **A link** having either two active LACP nodes or one active node can perform dynamic LACP trunk.
 2. **A link** having two passive LACP nodes will not perform dynamic LACP trunk because both ports are waiting for an LACP protocol packet from the opposite device.
-

Port Trunk - State Activity

Aggregator Setting Aggregator Information **State Activity**

Port	LACP State Activity	Port	LACP State Activity
1	<input checked="" type="checkbox"/> Active	2	<input checked="" type="checkbox"/> Active
3	<input checked="" type="checkbox"/> Active	4	<input checked="" type="checkbox"/> Active
5	N/A	6	N/A
7	N/A	8	N/A
9	N/A	10	N/A

Port Trunk – State Activity interface

Port Mirroring

The Port mirroring is a method for monitoring traffic in switched networks. Traffic through ports can be monitored by one specific port which means traffic goes in or out monitored (source) ports will be duplicated into mirroring (destination) port.

Port Mirroring

	Destination Port		Source Port	
	RX	TX	RX	TX
Port.01	<input checked="" type="radio"/>	<input type="radio"/>	<input checked="" type="checkbox"/>	<input checked="" type="checkbox"/>
Port.02	<input type="radio"/>	<input checked="" type="radio"/>	<input checked="" type="checkbox"/>	<input checked="" type="checkbox"/>
Port.03	<input type="radio"/>	<input type="radio"/>	<input checked="" type="checkbox"/>	<input type="checkbox"/>
Port.04	<input type="radio"/>	<input type="radio"/>	<input type="checkbox"/>	<input checked="" type="checkbox"/>
Port.05	<input type="radio"/>	<input type="radio"/>	<input checked="" type="checkbox"/>	<input type="checkbox"/>
Port.06	<input type="radio"/>	<input type="radio"/>	<input checked="" type="checkbox"/>	<input checked="" type="checkbox"/>
Port.07	<input type="radio"/>	<input type="radio"/>	<input checked="" type="checkbox"/>	<input checked="" type="checkbox"/>
Port.08	<input type="radio"/>	<input type="radio"/>	<input checked="" type="checkbox"/>	<input type="checkbox"/>
Port.09	<input type="radio"/>	<input type="radio"/>	<input type="checkbox"/>	<input checked="" type="checkbox"/>
Port.10	<input type="radio"/>	<input type="radio"/>	<input checked="" type="checkbox"/>	<input type="checkbox"/>

Port Trunk – Port Mirroring interface

- **Destination Port:** There is only one port can be selected to be the destination (mirroring) port for monitoring both RX and TX traffic which come from the source port. Or, use one of two ports for monitoring RX traffic only and the other one for TX traffic only. The user can connect the mirroring port to LAN analyzer or Netxray.
- **Source Port:** The ports that the user wants to monitor. All monitored port traffic will be copied to mirroring (destination) port. The user can select multiple source ports by ticking the **RX** or **TX** checkboxes to be monitored.
- And then, click button.

Rate Limiting

You can set up every port's frame limitation type and bandwidth rate.

Rate Limiting

	Ingress Limit Frame Type	Ingress	Egress
Port.01	All	0 kbps	0 kbps
Port.02	All	0 kbps	0 kbps
Port.03	Broadcast/Multicast/Flooded Unicast	0 kbps	0 kbps
	Broadcast/Multicast		
	Broadcast only		
Port.04	All	0 kbps	0 kbps
Port.05	All	0 kbps	0 kbps
Port.06	All	0 kbps	0 kbps
Port.07	All	0 kbps	0 kbps
Port.08	All	0 kbps	0 kbps
Port.09	All	0 kbps	0 kbps
Port.10	All	0 kbps	0 kbps

Rate Range is from 100 kbps to 102400 kbps or to 256000 kbps for giga ports, and zero means no limit.

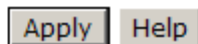

Rate Limiting interface

- **Ingress Limit Frame type:** Select the frame type you want to filter. The frame types have 4 options for selecting: **All**, **Broadcast/Multicast/Flooded Unicast**, **Broadcast/Multicast**, and **Broadcast only**.

The four frame type options are for ingress frames limitation. The egress rate only supports 'All' type.

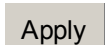
- All the ports support port ingress and egress rate control. For example, assume port 1 is 10Mbps; the user can set the effective egress rate of port 1 as 1Mbps, ingress rate 500Kbps. The switch performs the ingress rate by packet counter to meet the specified rate.
 - **Ingress:** Enter the port effective ingress rate (The default value is "0").
 - **Egress:** Enter the port effective egress rate (The default value is "0").
- And then, click  to make the settings taken effect.

VLAN configuration

A Virtual LAN (VLAN) is a logical network grouping that limits the broadcast domain, which would allow you to isolate network traffic, so only the members of the same VLAN will receive traffic from the ones of the same VLAN. Basically, creating a VLAN from a switch is logically equivalent of reconnecting a group of network devices to another Layer 2 switch. However, all the network devices are still plugged into the same switch physically.

The switch supports **Port-based** and **802.1Q** (tagged-based) VLAN. The default configuration of VLAN operation mode is “**Disable**”.

VLAN Configuration

VLAN Operation Mode :	Disable
<input type="checkbox"/> Enable GVRP Protocol	
Management Vlan ID :	0

VLAN NOT ENABLE

VLAN Configuration interface

VLAN configuration - Port-based VLAN

Packets can go among only members of the same VLAN group. Note all unselected ports are treated as belonging to another single VLAN. If the port-based VLAN enabled, the VLAN-tagging is ignored.

In order for an end station to send packets to different VLAN groups, it itself has to be either capable of tagging packets it sends with VLAN tags or attached to a VLAN-aware bridge that is capable of classifying and tagging the packet with different VLAN ID based

on not only default PVID but also other information about the packet, such as the protocol.

VLAN Configuration

VLAN Operation Mode :	Port Based ▾
<input type="checkbox"/> Enable GVRP Protocol	
Management Vlan ID :	0

Apply

--

Add Edit Delete Help

VLAN – Port Based interface

- Pull down the selection item and focus on **Port Based** then press **Apply** button to set the VLAN Operation Mode in **Port Based** mode.
- Click **Add** button to add a new VLAN group (The maximum VLAN group is up to 64 VLAN groups).

VLAN Configuration

VLAN Operation Mode :	Port Based ▾
<input type="checkbox"/> Enable GVRP Protocol	
Management Vlan ID :	0

Apply

Group Name	V_VLAN1	
VLAN ID	1	
Port.05 Port.06 Port.07 Port.08 Port.09 Port.10	<div style="text-align: center;"><input type="button" value="Add"/> <input type="button" value="Remove"/></div>	Port.01 Port.02 Port.03 Port.04

Apply Help

VLAN—Port Based Add interface

- Enter the group name and VLAN ID. Add the port number having selected into the right field to group these members to be a VLAN group or remove any of them listed in the right field from the VLAN.
- And then, click button to have the settings taken effect.
- You will see the VLAN displays.

VLAN Configuration

VLAN Operation Mode :	Port Based ▾
<input type="checkbox"/> Enable GVRP Protocol	
Management Vlan ID :	0

Apply

V_VLAN1___1

Add Edit Delete Help

VLAN—Port Based Edit/Delete interface

- Use **Delete** button to delete the VLAN.
- Use **Edit** button to modify group name, VLAN ID, or add/remove the members of the existing VLAN group.

[NOTE] Remember to execute the “Save Configuration” action, otherwise the new configuration will lose when switch power off.

802.1Q VLAN

Tagged-based VLAN is an IEEE 802.1Q specification standard. Therefore, it is possible to create a VLAN across devices from different switch vendors. IEEE 802.1Q VLAN uses a technique to insert a “tag” into the Ethernet frames. Tag contains a VLAN Identifier (VID) that indicates the VLAN numbers.

You can create Tag-based VLAN, and enable or disable GVRP protocol. There are 256 VLAN groups to provide configuration. Enable 802.1Q VLAN, all ports on the switch belong to default VLAN of VID 1. The default VLAN can't be deleted.

GVRP (GARP VLAN Registration Protocol) is a protocol that facilitates control of virtual local area networks (VLANs) within a larger network. GVRP conforms to the IEEE 802.1Q specification, which defines a method of tagging frames with VLAN configuration data. This allows network devices to dynamically exchange VLAN configuration information with other devices.

GVRP is based on GARP (Generic Attribute Registration Protocol), a protocol that defines procedures by which end stations and switches in a local area network (LAN) can register and de-register attributes, such as identifiers or addresses, with each other. Every end station and switch thus has a current record of all the other end stations and switches that can be reached.

802.1Q Configuration

- Pull down the selection item and focus on **802.1Q** then press button to set the VLAN Operation Mode in **802.1Q** mode.
- **Enable GVRP Protocol:** Tick the checkbox to enable GVRP protocol. This checkbox is available while the VLAN Operation Mode is in **802.1Q** mode.
- Select the port you want to configure.
- **Link Type:** There are 3 types of link type.
 - **Access Link:** Single switch only, it allows the user to group ports by assigning the same Untagged VID. While this link type is set, the Untagged VID column field is available but the Tagged VID column field is disabled.

- **Trunk Link:** The extended application of **Access Link**. It allows the user to group ports by assigning the same Tagged VID across 2 or more switches. Having set this link type, the Tagged VID column field is available but the Untagged VID column field is disabled.
- **Hybrid Link:** Both **Access Link** and **Trunk Link** are available.
- **Untagged VID:** Assign the untagged frame VID.
- **Tagged VID:** Assign the tagged frame VID.
- Click button to have the settings taken effect.
- You can see the link type, untagged VID, and tagged VID information of each port in the table below on the screen.

VLAN Configuration

VLAN Operation Mode :

Enable GVRP Protocol

Management Vlan ID :

802.1Q Configuration
Group Configuration

Port	Link Type	Untagged Vid	Tagged Vid
Port.06	Hybrid Link	2	1024

Access Link
Trunk Link
Hybrid Link

Port	Link Type	Untagged Vid	Tagged Vid
Port.01	Access Link	3	
Port.02	Access Link	3	
Port.03	Trunk Link	1	7,
Port.04	Trunk Link	1	7,
Port.05	Hybrid Link	2	1024,
Port.06	Access Link	1	
Port.07	Access Link	1	
Port.08	Access Link	1	
Port.09	Access Link	1	
Port.10	Access Link	1	

802.1Q VLAN interface

Group Configuration

Edit the existing VLAN Group.

- Select the VLAN group in the table list.
- Click  button.

VLAN Configuration

VLAN Operation Mode :	802.1Q
<input type="checkbox"/> Enable GVRP Protocol	
Management Vlan ID :	0

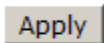

802.1Q Configuration

Group Configuration

Default	1
VLAN_2	2
VLAN_3	3
VLAN_7	7
VLAN_1024	1024

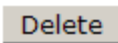
Group Configuration interface

- You can modify the VLAN group name and VLAN ID.

VLAN Configuration

VLAN Operation Mode :	802.1Q
<input type="checkbox"/> Enable GVRP Protocol	
Management Vlan ID :	0

Apply

802.1Q Configuration

Group Configuration

Group Name	VLAN_3
VLAN ID	3

Apply

Group Configuration interface

- Click  button.

Rapid Spanning Tree

The Rapid Spanning Tree Protocol (RSTP) is an evolution of the Spanning Tree Protocol and provides for faster spanning tree convergence after a topology change. The system also supports STP and the system will auto-detect the connected device that is running STP or RSTP protocol.

RSTP - System Configuration

- The user can view spanning tree information of Root Bridge.
- The user can modify RSTP state. After modification, click  button.
 - **RSTP mode:** The user must enable the RSTP function first before configuring the related parameters.
 - **Priority (0-61440):** The switch with the lowest value has the highest priority and is selected as the root. If the value is changed, the user must reboot the switch. The value must be a multiple of 4096 according to the protocol standard

rule.

- **Max Age (6-40):** The number of seconds a switch waits without receiving Spanning-tree Protocol configuration messages before attempting a reconfiguration. Enter a value between 6 through 40.
- **Hello Time (1-10):** The time that controls the switch to send out the BPDU packet to check RSTP current status. Enter a value between 1 through 10.
- **Forward Delay Time (4-30):** The number of seconds a port waits before changing from its Rapid Spanning-Tree Protocol learning and listening states to the forwarding state. Enter a value between 4 through 30.

[NOTE] Follow the rule as below to configure the MAX Age, Hello Time, and Forward Delay Time.

$2 \times (\text{Forward Delay Time value} - 1) \geq \text{Max Age value} \geq 2 \times (\text{Hello Time value} + 1)$

RSTP - System Configuration

System Configuration

Port Configuration

RSTP Mode	Enable ▾
Priority (0-61440)	32768
Max Age (6-40)	20
Hello Time (1-10)	2
Forward Delay Time (4-30)	15

Priority must be a multiple of 4096
 $2 \times (\text{Forward Delay Time} - 1)$ should be greater than or equal to the Max Age.
The Max Age should be greater than or equal to $2 \times (\text{Hello Time} + 1)$.

Apply Help

Root Bridge Information

Bridge ID	0080001122334455
Root Priority	32768
Root Port	Root
Root Path Cost	0
Max Age	20
Hello Time	2
Forward Delay	15

RSTP System Configuration interface

RSTP - Port Configuration

You can configure path cost and priority of every port.

- Select the port in the port column field.
- **Path Cost:** The cost of the path to the other bridge from this transmitting bridge at the specified port. Enter a number 1 through 200,000,000.
- **Priority:** Decide which port should be blocked by priority in LAN. Enter a number 0 through 240 (the port of the highest value will be blocked). The value of priority must be the multiple of 16.
- **Admin P2P:** Some of the rapid state transactions that are possible within RSTP are dependent upon whether the port concerned can only be connected to exactly one other bridge (i.e. it is served by a point-to-point LAN segment), or can be connected to two or more bridges (i.e. it is served by a shared medium LAN segment). This function allows the P2P status of the link to be manipulated administratively. True is P2P enabling. False is P2P disabling.
- **Admin Edge:** The port directly connected to end stations won't create bridging loop in the network. To configure the port as an edge port, set the port to "**True**" status.
- **Admin Non Stp:** The port includes the STP mathematic calculation. **True** is not including STP mathematic calculation. **False** is including the STP mathematic calculation.
- Click  .

RSTP - Port Configuration

Port	Path Cost (1-200000000)	Priority (0-240)	Admin P2P	Admin Edge	Admin Non Stp
Port.01 ▲					
Port.02					
Port.03	<input type="text" value="200000"/>	<input type="text" value="128"/>	<input type="text" value="Auto"/>	<input type="text" value="true"/>	<input type="text" value="false"/>
Port.04					
Port.05 ▼					

priority must be a multiple of 16

RSTP Port Status

Port	Path Cost	Port Priority	Oper P2P	Oper Edge	Stp Neighbor	State	Role
Port.01	200000	128	True	True	False	Disabled	Disabled
Port.02	200000	128	True	True	False	Disabled	Disabled
Port.03	200000	128	True	True	False	Disabled	Disabled
Port.04	200000	128	True	True	False	Disabled	Disabled
Port.05	200000	128	True	True	False	Disabled	Disabled
Port.06	200000	128	True	True	False	Disabled	Disabled
Port.07	20000	128	False	True	False	Forwarding	Designated
Port.08	200000	128	True	True	False	Disabled	Disabled
Port.09	20000	128	True	True	False	Disabled	Disabled
Port.10	20000	128	True	True	False	Disabled	Disabled

RSTP Port Configuration interface

SNMP Configuration

Simple Network Management Protocol (SNMP) is the protocol developed to manage nodes (servers, workstations, routers, switches and hubs etc.) on an IP network. SNMP enables network administrators to manage network performance, find and solve network problems, and plan for network growth. Network management systems learn of problems by receiving traps or change notices from network devices implementing SNMP.

System Configuration

■ Community Strings

Here you can define the new community string set and remove the unwanted community string.

- **String:** Fill the name string.
 - **RO:** Read only. Enables requests accompanied by this community string to display MIB-object information.
 - **RW:** Read write. Enables requests accompanied by this community string to display MIB-object information and to set MIB objects.
 - Click **Add** button.
 - To remove the community string, select the community string that you have defined and click **Remove** button. You cannot edit the name of the default community string set.
-
- **Agent Mode:** Select the SNMP version that you want to use and then click **Change** button to switch to the selected SNMP version mode. The default value is 'SNMP v1/v2c only'

SNMP - System Configuration

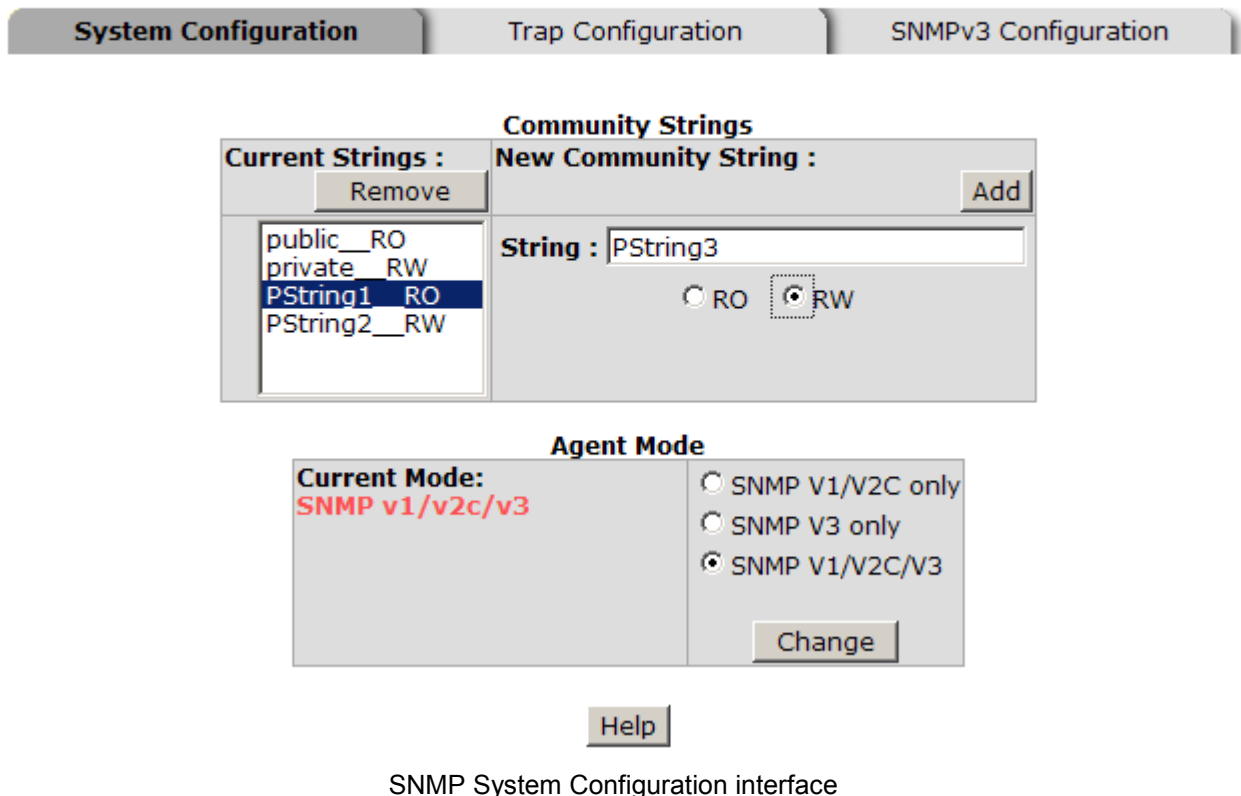

SNMP System Configuration interface

Trap Configuration

A trap manager is a management station that receives the trap messages generated by the switch. If no trap manager is defined, no traps will be issued. Create a trap manager by entering the IP address of the station and a community string. To define a management station as a trap manager, assign an IP address, enter the SNMP community strings, and select the SNMP trap version.

- **IP Address:** Enter the IP address of the trap manager.
- **Community:** Enter the community string.
- **Trap Version:** Select the SNMP trap version type—v1 or v2c.
- Click **Add** button.
- To remove the community string, select the community string listed in the current managers field and click **Remove** button.

SNMP - Trap Configuration

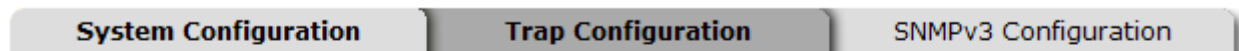

Trap Managers

Current Managers :	New Manager :
<input type="button" value="Remove"/>	<input type="button" value="Add"/>
192.168.16.21: TrapHost1, v1 192.168.16.22: TrapHost2, v2	IP Address : <input type="text" value="192.168.16.23"/> Community : <input type="text" value="TrapHost3"/> Trap version: <input checked="" type="radio"/> v1 <input type="radio"/> v2c

Trap Managers interface

SNMPV3 Configuration

Configure the SNMP V3 function.

Context Table

Configure SNMP v3 context table. Assign the context name of context table. Click to add context name. Click to remove the unwanted context name.

User Profile

Configure SNMP v3 user table..

- **User ID:** Set up the user name.
- **Authentication Password:** Set up the authentication password.
- **Privacy Password:** Set up the private password.
- Click to add the context name.
- Click to remove the unwanted context name.

SNMP - SNMPv3 Configuration

System Configuration

Trap Configuration

SNMPv3 Configuration

Context Table

Context Name :

User Table

Current User Profiles : <input type="button" value="Remove"/>	New User Profile : <input type="button" value="Add"/>
(none)	User ID: <input type="text"/>
	Authentication Password: <input type="text"/>
	Privacy Password: <input type="text"/>

Group Table

Current Group content : <input type="button" value="Remove"/>	New Group Table: <input type="button" value="Add"/>
(none)	Security Name (User ID): <input type="text"/>
	Group Name: <input type="text"/>

Access Table

Current Access Tables : <input type="button" value="Remove"/>	New Access Table : <input type="button" value="Add"/>
(none)	Context Prefix: <input type="text"/>
	Group Name: <input type="text"/>
	Security Level: <input type="radio"/> NoAuthNoPriv. <input type="radio"/> AuthNoPriv. <input type="radio"/> AuthPriv.
	Context Match Rule <input type="radio"/> Exact <input type="radio"/> Prefix
	Read View Name: <input type="text"/>
	Write View Name: <input type="text"/>
	Notify View Name: <input type="text"/>

MIBView Table

Current MIBTables : <input type="button" value="Remove"/>	New MIBView Table : <input type="button" value="Add"/>
(none)	View Name: <input type="text"/>
	SubOid-Tree: <input type="text"/>
	Type: <input type="radio"/> Excluded <input type="radio"/> Included

Note:

Any modification of SNMPv3 tables might cause MIB accessing rejection. Please take notice of the causality between the tables before you modify these tables.

SNMP V3 configuration interface

Group Table

Configure SNMP v3 group table.

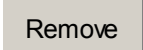
- **Security Name (User ID):** Assign the user name that you have set up in user table.
- **Group Name:** Set up the group name.
- Click  to add the context name.
- Click  to remove the unwanted context name.

Access Table

Configure SNMP v3 access table.

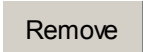
- **Context Prefix:** Set up the context name.
- **Group Name:** Set up the group.
- **Security Level:** Set up the access level.
- **Context Match Rule:** Select the context match rule.
- **Read View Name:** Set up the read view.
- **Write View Name:** Set up the write view.
- **Notify View Name:** Set up the notify view.
- Click  to add the context name.
- Click  to remove the unwanted context name.

MIBview Table

Configure MIB view table.

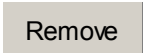
- **ViewName:** Set up the name.
- **Sub-Oid Tree:** Fill the Sub OID.
- **Type:** Select the type—excluded or included.
- Click  to add the context name.
- Click  to remove the unwanted context name.

QoS Configuration

Here you can configure QoS policy and priority setting, per port priority setting, COS and TOS setting.

QoS Policy and Priority Type

- **QoS Policy:** Select the QoS policy rule.
 - **Using the 8,4,2,1 weight fair queue scheme:** The switch will follow 8:4:2:1 rate to process priority queue from High to lowest queue. For example, while the system processing, 1 frame of the lowest queue, 2 frames of the low queue, 4 frames of the middle queue, and 8 frames of the high queue will be processed at the same time in accordance with the 8,4,2,1 policy rule.
 - **Use a strict priority scheme:** Always the higher queue will be processed first, except the higher queue is empty.
 - **Priority Type:** There are 5 priority type selections available—**Port-based, TOS only, COS only, TOS first,** and **COS first**. Disable means no priority type is selected.
- Click  button to make the settings effective.

QoS Configuration

Qos Policy:

Use an 8,4,2,1 weighted fair queuing scheme
 Use a strict priority scheme
Priority Type:

Port-based Priority:

Port.01	Port.02	Port.03	Port.04	Port.05	Port.06	Port.07	Port.08	Port.09	Port.10
<input type="text" value="Lowest"/>	<input type="text" value="Lowest"/>	<input type="text" value="Lowest"/>	<input type="text" value="Lowest"/>	<input type="text" value="Lowest"/>	<input type="text" value="Lowest"/>	<input type="text" value="Lowest"/>	<input type="text" value="Lowest"/>	<input type="text" value="Lowest"/>	<input type="text" value="Lowest"/>

COS:

Priority	0	1	2	3	4	5	6	7
	<input type="text" value="Lowest"/>	<input type="text" value="Lowest"/>	<input type="text" value="Lowest"/>	<input type="text" value="Lowest"/>	<input type="text" value="Lowest"/>	<input type="text" value="Lowest"/>	<input type="text" value="Lowest"/>	<input type="text" value="Lowest"/>

TOS:

Priority	0	1	2	3	4	5	6	7
	<input type="text" value="Lowest"/>	<input type="text" value="Lowest"/>	<input type="text" value="Lowest"/>	<input type="text" value="Lowest"/>	<input type="text" value="Lowest"/>	<input type="text" value="Lowest"/>	<input type="text" value="Lowest"/>	<input type="text" value="Lowest"/>
Priority	8	9	10	11	12	13	14	15
	<input type="text" value="Lowest"/>	<input type="text" value="Lowest"/>	<input type="text" value="Lowest"/>	<input type="text" value="Lowest"/>	<input type="text" value="Lowest"/>	<input type="text" value="Lowest"/>	<input type="text" value="Lowest"/>	<input type="text" value="Lowest"/>
Priority	16	17	18	19	20	21	22	23
	<input type="text" value="Lowest"/>	<input type="text" value="Lowest"/>	<input type="text" value="Lowest"/>	<input type="text" value="Lowest"/>	<input type="text" value="Lowest"/>	<input type="text" value="Lowest"/>	<input type="text" value="Lowest"/>	<input type="text" value="Lowest"/>
Priority	24	25	26	27	28	29	30	31
	<input type="text" value="Lowest"/>	<input type="text" value="Lowest"/>	<input type="text" value="Lowest"/>	<input type="text" value="Lowest"/>	<input type="text" value="Lowest"/>	<input type="text" value="Lowest"/>	<input type="text" value="Lowest"/>	<input type="text" value="Lowest"/>
Priority	32	33	34	35	36	37	38	39
	<input type="text" value="Lowest"/>	<input type="text" value="Lowest"/>	<input type="text" value="Lowest"/>	<input type="text" value="Lowest"/>	<input type="text" value="Lowest"/>	<input type="text" value="Lowest"/>	<input type="text" value="Lowest"/>	<input type="text" value="Lowest"/>
Priority	40	41	42	43	44	45	46	47
	<input type="text" value="Lowest"/>	<input type="text" value="Lowest"/>	<input type="text" value="Lowest"/>	<input type="text" value="Lowest"/>	<input type="text" value="Lowest"/>	<input type="text" value="Lowest"/>	<input type="text" value="Lowest"/>	<input type="text" value="Lowest"/>
Priority	48	49	50	51	52	53	54	55
	<input type="text" value="Lowest"/>	<input type="text" value="Lowest"/>	<input type="text" value="Lowest"/>	<input type="text" value="Lowest"/>	<input type="text" value="Lowest"/>	<input type="text" value="Lowest"/>	<input type="text" value="Lowest"/>	<input type="text" value="Lowest"/>
Priority	56	57	58	59	60	61	62	63
	<input type="text" value="Lowest"/>	<input type="text" value="Lowest"/>	<input type="text" value="Lowest"/>	<input type="text" value="Lowest"/>	<input type="text" value="Lowest"/>	<input type="text" value="Lowest"/>	<input type="text" value="Lowest"/>	<input type="text" value="Lowest"/>

QoS Configuration interface

Port-based Priority

Configure the priority level for each port. With the drop-down selection item of **Priority Type** above being selected as Port-based, this control item will then be available to set the queuing policy for each port.

- **Port x:** Each port has 4 priority levels—High, Middle, Low, and Lowest—to be chosen.
- Click  button to make the settings effective.

COS Configuration

Set up the COS priority level. With the drop-down selection item of **Priority Type** above being selected as COS only/COS first, this control item will then be available to set the queuing policy for each port.

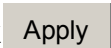
- **COS priority:** Set up the COS priority level 0~7—High, Middle, Low, Lowest.
- Click .

TOS Configuration

Set up the TOS priority. With the drop-down selection item of **Priority Type** above being selected as TOS only/TOS first, this control item will then be available to set the queuing policy for each port.

- **TOS priority:** The system provides 0~63 TOS priority level. Each level has 4 types of priority—High, Middle, Low, and Lowest. The default value is 'Lowest' priority for each level. When the IP packet is received, the system will check the TOS level value in the IP packet that has received. For example, the user sets the TOS level 25 as high, the system will check the TOS value of the received IP packet. If the TOS value of received IP packet is 25 (priority = high), and then the packet priority will have highest priority.
- Click  button to make the settings effective.

IGMP Configuration

The Internet Group Management Protocol (IGMP) is an internal protocol of the Internet Protocol (IP) suite. IP manages multicast traffic by using switches, routers, and hosts that support IGMP. Enabling IGMP allows the ports to detect IGMP queries, report packets, and manage IP multicast traffic through the switch. IGMP have three fundamental types of message shown as follows:

Message	Description
Query	A message sent from the querier (IGMP router or switch) asking for a response from each host belonging to the multicast group.
Report	A message sent by a host to the querier to indicate that the host wants to be or is a member of a given group indicated in the report message.
Leave Group	A message sent by a host to the querier to indicate that the host has quit being a member of a specific multicast group.

The switch supports IP multicast. You can enable IGMP protocol via setting the IGMP Configuration page to see the IGMP snooping information. IP multicast addresses are in the range of 224.0.0.0 through 239.255.255.255.

- **IGMP Protocol:** Enable or disable the IGMP protocol.
- **IGMP Query:** Select the IGMP query function as Enable or Auto to set the switch as a querier for IGMP version 2 multicast networks.
- Click button.

IGMP Configuration

IP Address	VLAN ID	Member Port
239.255.255.250	1	*****15****

IGMP Snooping:

IGMP Query:

IGMP Configuration interface

X-Ring

X-Ring provides a faster redundant recovery than Spanning Tree topology. The action is similar to STP or RSTP, but the algorithms between them are not the same.

In the X-Ring topology, every switch should be enabled with X-Ring function and two ports should be assigned as the member ports in the ring. Only one switch in the X-Ring group would be set as the master switch that one of its two member ports would be blocked, called backup port, and another port is called working port. Other switches in the X-Ring group are called working switches and their two member ports are called working ports. When the failure of network connection occurs, the backup port of the master switch (Ring Master) will automatically become a working port to recover from the failure.

The switch supports the function and interface for setting the switch as the ring master or not. The ring master can negotiate and place command to other switches in the X-Ring group. If there are 2 or more switches in master mode, the software will select the switch with lowest MAC address number as the ring master. The X-Ring master ring mode can be enabled by setting the X-Ring configuration interface. Also, the user can identify

whether the switch is the ring master by checking the R.M. LED indicator on the panel of the switch.

The system also supports the **Couple Ring** that can connect 2 or more X-Ring group for the redundant backup function; **Dual Homing** function that can prevent connection lose between X-Ring group and upper level/core switch. Apart from the advantages, **Central Ring** can handle up to 4 rings in the system and has the ability to recover from failure within 20 milliseconds.

- **Enable Ring:** To enable the X-Ring function, tick the checkbox beside the **Enable Ring** string label. If this checkbox is not ticked, all the ring functions are unavailable.
 - **Enable Ring Master:** Tick the checkbox to enable this switch to be the ring master.
 - **1st & 2nd Ring Ports:** Pull down the selection menu to assign the ports as the member ports. **1st Ring Port** is the working port and **2nd Ring Port** is the backup port. When **1st Ring Port** fails, the system will automatically upgrade the **2nd Ring Port** to be the working port.
- **Enable Couple Ring:** To enable the couple ring function, tick the checkbox beside the **Enable Couple Ring** string label.
 - **Couple Port:** Assign the member port which is connected to the other ring group.
 - **Control Port:** When the **Enable Couple Ring** checkbox is ticked, you have to assign the control port to form a couple-ring group between the two X-rings.
- **Enable Dual Homing:** Set up one of the ports on the switch to be the Dual Homing port. For a switch, there is only one Dual Homing port. Dual Homing function only works when the X-Ring function enabled.
 - **Homing Port:** Assign a port which is used to be the dual homing port.
- And then, click button to apply the configuration.

X-Ring Configuration

<input checked="" type="checkbox"/> Enable Ring		
<input type="checkbox"/> Enable Ring Master		
1st Ring Port	Port.01 ▾	LINKDOWN
2nd Ring Port	Port.02 ▾	LINKDOWN
<input type="checkbox"/> Enable Couple Ring		
Couple Port	Port.03 ▾	LINKDOWN
Control Port	Port.04 ▾	LINKDOWN
<input type="checkbox"/> Enable Dual Homing		
Homing Port	Port.05 ▾	LINKDOWN

X-ring Interface

-
- [NOTE]**
1. When the X-Ring function enabled, the user must disable the RSTP. The X-Ring function and RSTP function cannot exist on a switch at the same time.
 2. Remember to execute the “Save Configuration” action, otherwise the new configuration will lose when switch powers off.
-

Security

In this section, you can configure the 802.1x and MAC address table.

802.1X/RADIUS Configuration

802.1x is an IEEE authentication specification which prevents the client from connecting to a wireless access point or wired switch until it provides authority, like the user name and password that are verified by an authentication server (such as RADIUS server).

System Configuration

After enabling the IEEE 802.1X function, you can configure the parameters of this function.

- **IEEE 802.1x Protocol:** Enable or disable 802.1x protocol.
- **Radius Server IP:** Assign the RADIUS Server IP address.
- **Server Port:** Set the UDP destination port for authentication requests to the specified RADIUS Server.
- **Accounting Port:** Set the UDP destination port for accounting requests to the specified RADIUS Server.
- **Shared Key:** Set an encryption key for using during authentication sessions with the specified RADIUS server. This key must match the encryption key used on the RADIUS Server.
- **NAS, Identifier:** Set the identifier for the RADIUS client.
- Click  button.

802.1x/Radius - System Configuration

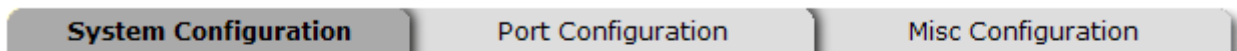

802.1x Protocol	Enable ▾
Radius Server IP	192.168.16.235
Server Port	1812
Accounting Port	1813
Shared Key	12345678
NAS, Identifier	NAS_L2_SWITCH



802.1x System Configuration interface

802.1x Per Port Configuration

You can configure the 802.1x authentication state for each port. The state provides Disable, Accept, Reject, and Authorize.

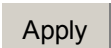
- **Reject:** The specified port is required to be held in the unauthorized state.
- **Accept:** The specified port is required to be held in the Authorized state.
- **Authorized:** The specified port is set to the Authorized or Unauthorized state in accordance with the outcome of an authentication exchange between the Supplicant and the authentication server.
- **Disable:** When disabled, the specified port works without complying with 802.1x protocol.
- Click  button.

802.1x/RADIUS - Port Configuration

System Configuration

Port Configuration

Misc Configuration

Port	State
Port.01	Authorize
Port.02	Accept
Port.03	Reject
Port.04	Authorize
Port.05	Disable

Apply Help

Port Authorization

Port	State
Port.01	Authorize
Port.02	Accept
Port.03	Reject
Port.04	Authorize
Port.05	Disable
Port.06	Disable
Port.07	Disable
Port.08	Disable
Port.09	Disable

802.1x Per Port Setting interface

Misc Configuration

- **Quiet Period:** Set the period which the port doesn't try to acquire a supplicant.
- **TX Period:** Set the period the port waits for retransmit next EAPOL PDU during an authentication session.
- **Supplicant Timeout:** Set the period of time the switch waits for a supplicant response to an EAP request.
- **Server Timeout:** Set the period of time the switch waits for a server response to an authentication request.
- **Max Requests:** Set the number of authentication that must time-out before authentication fails and the authentication session ends.
- **Reauth period:** Set the period of time which clients connected must be re-authenticated.
- Click  button.

802.1x/RADIUS - Misc Configuration

System Configuration	Port Configuration	Misc Configuration
Quiet Period		<input type="text" value="60"/>
Tx Period		<input type="text" value="30"/>
Supplicant Timeout		<input type="text" value="30"/>
Server Timeout		<input type="text" value="30"/>
Max Requests		<input type="text" value="2"/>
Reauth Period		<input type="text" value="3600"/>

802.1x Misc Configuration interface

MAC Address Table

Use the MAC address table to ensure the port security.

Static MAC Address

You can add a static MAC address; it remains in the switch's address table, regardless of whether the device is physically connected to the switch. This saves the switch from having to re-learn a device's MAC address when the disconnected or powered-off device is active on the network again. You can add / modify / delete a static MAC address.

Add the Static MAC Address

You can add static MAC address in the switch MAC table here.

- **MAC Address:** Enter the MAC address of the port that should permanently forward traffic, regardless of the device network activity.
- **Port No.:** Pull down the selection menu to select the port number.
- Click button.
- If you want to delete the MAC address from filtering table, select the MAC address

and click **Delete** button.

MAC Address Table - Static MAC Addresses

Static MAC Addresses	MAC Filtering	All Mac Addresses
----------------------	---------------	-------------------

AABBCCDDEEFF	Port.01
--------------	---------

MAC Address	FFEEDDCCBBAA
Port No.	Port.01

Add **Delete** **Help**

Static MAC Addresses interface

MAC Filtering

By filtering MAC address, the switch can easily filter the pre-configured MAC address and reduce the un-safety. You can add and delete filtering MAC address.

MAC Address Table - MAC Filtering

Static MAC Addresses	MAC Filtering	All Mac Addresses
----------------------	---------------	-------------------

EEFFDDCCBBAA

MAC Address	BBAACDDFFEE
-------------	-------------

Add **Delete** **Help**

MAC Filtering interface

1. **MAC Address:** Enter the MAC address that you want to filter.
2. Click button.
3. If you want to delete the MAC address from the filtering table, select the MAC address and click button.

All MAC Addresses

You can view the port that connected device's MAC address and the related devices' MAC address.

1. Select the port.
2. The selected port of static & dynamic MAC address information will be displayed in here.
3. Click to clear the current port static MAC address information on screen.

MAC Address Table - All Mac Addresses

Static MAC Addresses	MAC Filtering	All Mac Addresses
----------------------	---------------	--------------------------

Port No: Port.01
AABBCCDDEEFF _____ STATIC
Dynamic Address Count:0 Static Address Count:1



All MAC Address interface

Factory Default

Reset switch to default configuration. Click  button to reset all configurations to the default value.

Factory Default

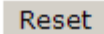
- Keep current IP address setting?
- Keep current username & password?



 

Factory Default interface

Save Configuration

Save all configurations that you have made in the system. To ensure the all configuration will be saved. Click  to save the all configuration to the flash memory.

Save Configuration

Save Configuration interface

System Reboot

Reboot the switch in software reset. Click  to reboot the system.

System Reboot

Please click [**Reboot**] button to restart switch device.

Reboot

System Reboot interface

Troubles shooting

- Verify that you are using the right power cord/adapter (DC 12 ~ 48V). Please don't use the power adapter with DC output higher than 48V, or this switch will be burned down.
- Select the proper UTP/STP cable to construct the user network. Use unshielded twisted-pair (UTP) or shield twisted-pair (STP) cable for RJ-45 connections: 100 Ω Category 3, 4 or 5 cable for 10Mbps connections, 100 Ω Category 5 cable for 100Mbps connections, or 100 Ω Category 5e/above cable for 1000Mbps connections. Also be sure that the length of any twisted-pair connection does not exceed 100 meters (328 feet).
- **Diagnosing LED Indicators:** To assist in identifying problems, the switch can be easily monitored through panel indicators, which describe common problems the user may encounter and where the user can find possible solutions.
- If the power indicator does not light on when the power cord is plugged in, you may have a problem with power cord. Then check for loose power connections, power losses or surges at power outlet. If you still cannot resolve the problem, contact the local dealer for assistance.
- If the LED indicators are normal and the connected cables are correct but the packets still cannot be transmitted. Please check the user system's Ethernet devices' configuration or status.

Technical Specification

The 7 10/100TX + 3 10/100/1000T/100/1000 SFP Combo w/ X-Ring L2 Managed Industrial Switch technical specification are as follows.

Standard	IEEE 802.3 10Base-T IEEE 802.3u 100Base-TX IEEE 802.3ab 1000Base-T IEEE 802.3z Gigabit fiber IEEE 802.3x Flow Control and Back-pressure IEEE 802.3ad Port trunk with LACP IEEE 802.1d Spanning Tree IEEE 802.1w Rapid Spanning Tree IEEE 802.1p Class of Service IEEE 802.1Q VLAN Tag IEEE 802.1x User Authentication (RADIUS) IEEE 802.1ab LLDP**
Protocol	CSMA/CD
Transfer Rate	14,880 pps for 10Base-T Ethernet port 148,800 pps for 100Base-TX/FX Fast Ethernet port 1,488,000 pps for Gigabit Fiber Ethernet port
MAC address	8K MAC address table
Packet Buffer	1Mbits
Flash ROM	4Mbytes
DRAM	32Mbytes
Connector	10/100TX: 7 x RJ-45 10/100/1000T/ Mini-GBIC Combo: 3 x RJ-45 + 3 x 100/1000 SFP sockets

	RS-232 connector: RJ-45 type
DI/DO	2 Digital Input (DI) : Level 0 : -30~2V Level 1 : 10~30V Max. input current: 8mA 2 Digital Output (DO): Open collector to 24 VDC, 1A
LED	Per unit: Power (Green), Power 1 (Green), Power 2 (Green), Fault (Red), Master (Green) 10/100TX: Link/Activity (Green), Full duplex/Collision (Yellow) Gigabit Copper: Link/Activity (Green), Speed (1000Mbps Green) SFP: Link/Activity (Green)
Network Cable	10Base-T: 2-pair UTP/STP Cat. 3, 4, 5 cable EIA/TIA-568 100-ohm (100m) 100Base-TX: 2-pair UTP/STP Cat. 5 cable EIA/TIA-568 100-ohm (100m) 1000Base-T: 2-pair UTP/STP Cat. 5e or 6 cable EIA/TIA-568 100-ohm (100m)
Optical cable	<ul style="list-style-type: none"> ■ LC (Multi-mode): 50/125um or 62.5/125um ■ LC (Single mode): 9/125um
Back-plane	7.4Gbps
Packet throughput ability	11Mpps at 64bytes
Power Supply	12 ~ 48V _{DC} Redundant power with polarity reverse protection and removable terminal block (The power supply should meet the “document listed by UL” and its output must comply with L.P.S)

Power Consumption	10.2 Watts
Install	DIN Rail and Wall Mount Design
Operating Temperature	-10°C to 60°C
Operation Humidity	5% to 95% (Non-condensing)
Storage Temperature	-40°C to 85°C
Case Dimension	IP-30, 72 mm (W) x 105 mm (D) x 152mm (H)
EMI	FCC Class A CE EN61000-4-2 (ESD) CE EN61000-4-3 (RS) CE EN61000-4-4 (EFT) CE EN61000-4-5 (Surge) CE EN61000-4-6 (CS) CE EN61000-4-8 CE EN61000-4-11 CE EN61000-4-12 CE EN61000-6-2 CE EN61000-6-4
Safety	UL cUL CE/EN60950-1
Stability testing	IEC60068-2-32 (Free fall) IEC60068-2-27 (Shock) IEC60068-2-6 (Vibration)